



The soul of ceramic
**BATHROOM
FITTINGS**



Voices: the soul of ceramic is the new project by Terratinta Group that combines thin slabs, bathroom furniture, thermo-structured panels and shower trays to offer a complete and flexible project to customize bathroom spaces.

With Voices, Terratinta Group offers a selection of floors and walls inspired by music. From the elegance of the opera to the liveliness of rock, crossing through the virtuosity of blues and jazz, the Voices project reflects the musical vocalization through different styles that combine material and color, finishes and geometries, with a reverberation that refers to four interpretations of modern bathroom.

The synergy created by Terratinta Group with Studio Lucchese, Arbi Arredobagno and Fir Italia, realities of experience in their sectors, is the harmonious background on which to build a new symphony.

Voices: the soul of ceramic è il nuovo progetto di Terratinta Group che unisce lastre di spessore sottile, elementi di arredobagno, termoarredo e piatti doccia per offrire un progetto completo e flessibile per la personalizzazione degli spazi bagno.

Terratinta Group propone con Voices una selezione di pavimenti e rivestimenti ispirati alla musica.

Dall'eleganza dell'opera alla vivacità del rock, passando attraverso i virtuosismi del blues e del jazz, il progetto Voices riflette i vocalizzi musicali attraverso stili diversi che accostano materia e colore, finiture e geometrie, con un riverbero che rimanda a quattro modi di interpretare il bagno oggi.


La sinergia creata da Terratinta Group con Studio Lucchese, Arbi Arredobagno e Fir Italia, realtà d'esperienza nei propri settori, è il sottofondo armonioso su cui costruire una sinfonia nuova.

BATHROOM FITTINGS
RUBINETTERIA e ACCESSORI BAGNO

LifeSteel 59



The articles included in LifeSteel 59 collection are available in the following finish: **AISI 316L stainless steel**
 Gli articoli della collezione LifeSteel 59 sono disponibili nella finitura: **acciaio inossidabile AISI 316L**

 **AISI 316L stainless steel/acciaio inossidabile**

TECHNICAL DATA / DATI TECNICI

65° (max 80° C)

Optimal hot water temperature
 Temperatura ottimale acqua calda

3 bar (min 1 - max 5)

Optimal operational pressure
 Pressione ottimale di esercizio

0,1 bar (max 1)

Hot/cold water pressure difference
 Differenza di pressione acqua calda/fredda

REMARKS / AVVERTENZE

For the single lever mixers FIR ITALIA recommends the assembling of removable filter elbow connections (Art. 11.0506.2) in order to avoid possible obstructions or damages to the cartridge caused by deposit conveyed by water.

Per i miscelatori monocomando FIR ITALIA consiglia l'installazione sulle due mandate di rubinetti filtro ispezionabili (Art. 11.0506.2), per trattenere eventuali corpi estranei che potrebbero danneggiare gli organi di tenuta della cartuccia.


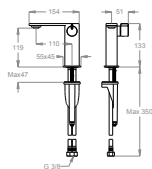


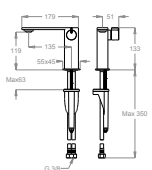


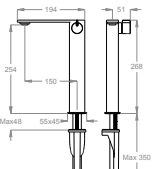


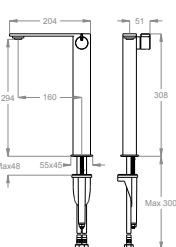

PHOTO / FOTO	DRAWING / DISEGNO	DESCRIPTION / DESCRIZIONE	Item / Finish Art./ Finitura
   <p>0500473 0590546 5 L/min EN 817</p>	<p>Wash basin mixer, 133 mm high, center distance 110 mm long, without pop-up drain and hole for pull-rod. <i>Miscelatore lavabo h. 133 mm, interasse 110 mm, senza scarico e senza foro per salterello.</i></p>	<p>59.1120.0</p>	
   <p>0500473 0590546 5 L/min EN 817</p>	<p>Wash basin mixer, 133 mm high, center distance 135 mm long, without pop-up drain and hole for pull-rod. <i>Miscelatore lavabo h. 133 mm, interasse 135 mm, senza scarico e senza foro per salterello.</i></p>	<p>59.1130.0</p>	
   <p>0500473 0590546 5 L/min EN 817</p>	<p>Wash basin mixer, 268 mm high, center distance 150 mm long, without pop-up drain and hole for pull-rod. <i>Miscelatore lavabo h. 268 mm, interasse 150 mm, senza scarico e senza foro per salterello.</i></p>	<p>59.1140.0</p>	
   <p>0500473 0590546 5 L/min EN 817</p>	<p>Wash basin mixer, 308 mm high, center distance 160 mm long, without pop-up drain and hole for pull-rod. <i>Miscelatore lavabo h. 308 mm, interasse 160 mm, senza scarico e senza foro per salterello.</i></p>	<p>59.1150.0</p>	



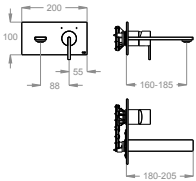



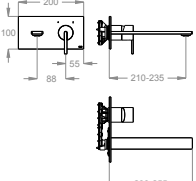



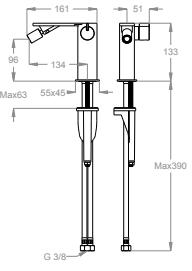


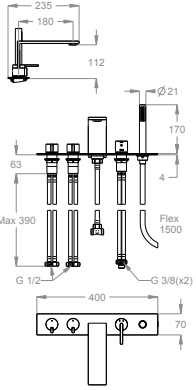
PHOTO / FOTO	DRAWING / DISEGNO	DESCRIPTION / DESCRIZIONE	Item / Finish Art./ Finitura
  <p>0500473 0590576 5 L/min EN 817</p>		<p>External part for wall-mounted built-in basin mixer with plate, 205 mm long, center distance 185 mm long.</p> <p><i>Parte esterna miscelatore lavabo incasso a parete con piastra, lunghezza 205 mm, interasse 185 mm.</i></p> <p>Necessary complementary items <i>Articoli complementari necessari</i></p>  <p>05.1000.0 05.00 Raw Brass FirUnico® universal built-in system. <i>Sistema incasso universale FirUnico®.</i></p>	<p>59.1010.8</p> <p>50.00 Stainless Steel</p>
  <p>0500473 0590576 5 L/min EN 817</p>		<p>External part for wall-mounted built-in basin mixer with plate, 255 mm long, center distance 235 mm long.</p> <p><i>Parte esterna miscelatore lavabo incasso a parete con piastra, lunghezza 255 mm, interasse 235 mm.</i></p> <p>Necessary complementary items <i>Articoli complementari necessari</i></p>  <p>05.1000.0 05.00 Raw Brass FirUnico® universal built-in system. <i>Sistema incasso universale FirUnico®.</i></p>	<p>59.1020.8</p> <p>50.00 Stainless Steel</p>
  <p>0500474 0590546</p>		<p>Bidet mixer, 133 mm high, center distance 134 mm long, without pop-up drain and hole for pull-rod.</p> <p><i>Miscelatore bidet h. 133 mm, interasse 134 mm, senza scarico e senza foro per salterello.</i></p>	<p>59.2101.0</p> <p>50.00 Stainless Steel</p>
  <p>0500624 0540045 0590544 0590412 L=1500</p>		<p>Deck-mounted bath mixer with shower set.</p> <p><i>Gruppo bordo vasca al piano, con doccetta duplex.</i></p>	<p>59.3140.4</p> <p>50.00 Stainless Steel</p>


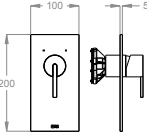



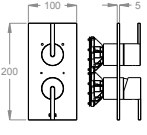



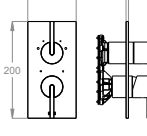



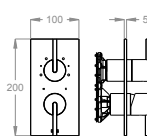



PHOTO / FOTO	DRAWING / DISEGNO	DESCRIPTION / DESCRIZIONE	Item / Finish Art./ Finitura
   <p>0590576 EN 817</p>		<p>External part for wall-mounted built-in one-way shower mixer. <i>Parte esterna miscelatore doccia incasso a parete a una uscita.</i></p> <p>Necessary complementary items <i>Articoli complementari necessari</i></p> <p> 05.1000.0 05.00 Raw Brass FirUnico® universal built-in system. <i>Sistema incasso universale FirUnico®.</i></p>	<p>59.5015.8</p> <p>50.00 Stainless Steel</p>
   <p>0590576 0590575 EN 817</p>		<p>External part for wall-mounted built-in shower mixer with two-way diverter. <i>Parte esterna miscelatore doccia incasso a parete con deviatore a due uscite.</i></p> <p>Necessary complementary items <i>Articoli complementari necessari</i></p> <p> 05.1000.0 05.00 Raw Brass FirUnico® universal built-in system. <i>Sistema incasso universale FirUnico®.</i></p>	<p>59.5017.8</p> <p>50.00 Stainless Steel</p>
   <p>0590576 0590577 EN 817</p>		<p>External part for wall-mounted built-in shower mixer with three-way diverter. <i>Parte esterna miscelatore doccia incasso a parete con deviatore a tre uscite.</i></p> <p>Necessary complementary items <i>Articoli complementari necessari</i></p> <p> 05.1000.0 05.00 Raw Brass FirUnico® universal built-in system. <i>Sistema incasso universale FirUnico®.</i></p>	<p>59.5018.8</p> <p>50.00 Stainless Steel</p>
   <p>0590576 0590577 EN 817</p>		<p>External part for wall-mounted built-in shower mixer with four-way diverter. <i>Parte esterna miscelatore doccia incasso a parete con deviatore a quattro uscite.</i></p> <p>Necessary complementary items <i>Articoli complementari necessari</i></p> <p> 05.1000.0 05.00 Raw Brass FirUnico® universal built-in system. <i>Sistema incasso universale FirUnico®.</i></p>	<p>59.5019.8</p> <p>50.00 Stainless Steel</p>

PHOTO / FOTO	DRAWING / DISEGNO	DESCRIPTION / DESCRIZIONE	Item / Finish Art./ Finitura
   <p>Thermo 0590581 EN 1111</p>		<p>External part for wall-mounted built-in thermostatic shower mixer with stop valve. <i>Parte esterna miscelatore doccia incasso termostatico a parete con rubinetto d'arresto.</i></p> <hr/> <p>Necessary complementary items <i>Articoli complementari necessari</i></p> <p> 05.1000.0 05.00 Raw Brass FirUnico® universal built-in system. <i>Sistema incasso universale FirUnico®.</i></p>	<p>58.8015.8</p> <hr/> <p>50.00 Stainless Steel</p>
   <p>Thermo 0590581 0590575 EN 1111</p>		<p>External part for wall-mounted built-in thermostatic shower mixer with stop valve and two-way diverter. <i>Parte esterna miscelatore doccia incasso termostatico a parete con rubinetto d'arresto e deviatore a due uscite.</i></p> <hr/> <p>Necessary complementary items <i>Articoli complementari necessari</i></p> <p> 05.1000.0 05.00 Raw Brass FirUnico® universal built-in system. <i>Sistema incasso universale FirUnico®.</i></p>	<p>58.8017.8</p> <hr/> <p>50.00 Stainless Steel</p>
   <p>Thermo 0590581 0590577 EN 1111</p>		<p>External part for wall-mounted built-in thermostatic shower mixer with stop valve and three-way diverter. <i>Parte esterna miscelatore doccia incasso termostatico a parete con rubinetto d'arresto e deviatore a tre uscite.</i></p> <hr/> <p>Necessary complementary items <i>Articoli complementari necessari</i></p> <p> 05.1000.0 05.00 Raw Brass FirUnico® universal built-in system. <i>Sistema incasso universale FirUnico®.</i></p>	<p>58.8018.8</p> <hr/> <p>50.00 Stainless Steel</p>
   <p>Thermo 0590581 0590577 EN 1111</p>		<p>External part for wall-mounted built-in thermostatic shower mixer with stop valve and four-way diverter. <i>Parte esterna miscelatore doccia incasso termostatico a parete con rubinetto d'arresto e deviatore a quattro uscite.</i></p> <hr/> <p>Necessary complementary items <i>Articoli complementari necessari</i></p> <p> 05.1000.0 05.00 Raw Brass FirUnico® universal built-in system. <i>Sistema incasso universale FirUnico®.</i></p>	<p>58.8019.8</p> <hr/> <p>50.00 Stainless Steel</p>

CleoSteel 48



The articles included in CleoSteel 48 collection are available in the following finishings: **AISI 316L stainless steel**
 Gli articoli della collezione CleoSteel 48 sono disponibili nelle finiture sotto indicate: **acciaio inossidabile AISI 316L**

 **AISI 316L stainless steel/acciaio inossidabile**

TECHNICAL DATA / DATI TECNICI

65° (max 80° C)

Optimal hot water temperature
 Temperatura ottimale acqua calda

3 bar (min 1 - max 5)

Optimal operational pressure
 Pressione ottimale di esercizio

0,1 bar (max 1)

Hot/cold water pressure difference
 Differenza di pressione acqua calda/fredda

REMARKS / AVVERTENZE

For the single lever mixers FIR ITALIA recommends the assembling of removable filter elbow connections (Art. 11.0506.2) in order to avoid possible obstructions or damages to the cartridge caused by deposit conveyed by water.

Per i miscelatori monocomando FIR ITALIA consiglia l'installazione sulle due mandate di rubinetti filtro ispezionabili (Art. 11.0506.2), per trattenere eventuali corpi estranei che potrebbero danneggiare gli organi di tenuta della cartuccia.



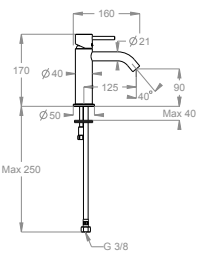


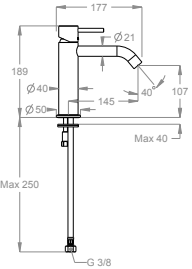


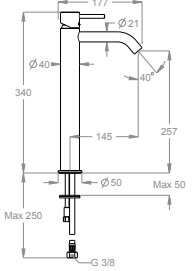
PHOTO / FOTO	DRAWING / DISEGNO	DESCRIPTION / DESCRIZIONE	Item / Finish Art./ Finitura
  0500470 0590543 5 L/min EN 817		Wash basin mixer, 170 mm high, center distance 125 mm long, without pop-up drain and hole for pull-rod. Miscelatore lavabo h. 170 mm, interasse 125 mm, senza scarico e senza foro per salterello.	48.1120.0 50.00 Stainless Steel
  0500470 0590543 5 L/min EN 817		Wash basin mixer, 189 mm high, center distance 145 mm long, without pop-up drain and hole for pull-rod. Miscelatore lavabo h. 189 mm, interasse 145 mm, senza scarico e senza foro per salterello.	48.1130.0 50.00 Stainless Steel
  0500470 0590543 5 L/min EN 817		Wash basin mixer, 340 mm high, center distance 145 mm long, without pop-up drain and hole for pull-rod. Miscelatore lavabo h. 340 mm, interasse 145 mm, senza scarico e senza foro per salterello.	48.1140.0 50.00 Stainless Steel



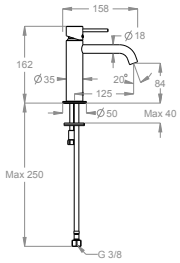


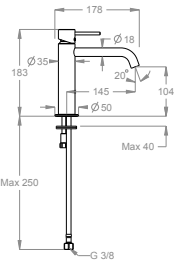


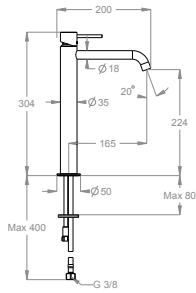


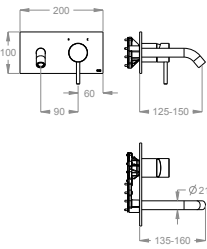

PHOTO / FOTO	DRAWING / DISEGNO	DESCRIPTION / DESCRIZIONE	Item / Finish Art./ Finitura
  <p>0500471 0590542 5 L/min EN 817</p>		<p>CLEOSTEEL MINI - Wash basin mixer, 162 mm high, center distance 125 mm long, without pop-up drain and hole for pull-rod.</p> <p><i>CLEOSTEEL MINI - Miscelatore lavabo h. 162 mm, interasse 125 mm, senza scarico e senza foro per salterello.</i></p>	<p>48.1170.0</p> <p>50.00 Stainless Steel</p>
  <p>0500471 0590542 5 L/min EN 817</p>		<p>CLEOSTEEL MINI - Wash basin mixer, 183 mm high, center distance 145 mm long, without pop-up drain and hole for pull-rod.</p> <p><i>CLEOSTEEL MINI - Miscelatore lavabo h. 183 mm, interasse 145 mm, senza scarico e senza foro per salterello.</i></p>	<p>48.1180.0</p> <p>50.00 Stainless Steel</p>
  <p>0500471 0590542 5 L/min EN 817</p>		<p>CLEOSTEEL MINI - Wash basin mixer, 304 mm high, center distance 165 mm long, without pop-up drain and hole for pull-rod.</p> <p><i>CLEOSTEEL MINI - Miscelatore lavabo h. 304 mm, interasse 165 mm, senza scarico e senza foro per salterello.</i></p>	<p>48.1190.0</p> <p>50.00 Stainless Steel</p>
  <p>0500470 0590576 5 L/min EN 817</p>		<p>External part for wall-mounted built-in basin mixer with plate, 160 mm long, center distance 150 mm long.</p> <p><i>Parte esterna miscelatore lavabo incasso a parete con piastra, lunghezza 160 mm, interasse 150 mm.</i></p> <p>Necessary complementary items <i>Articoli complementari necessari</i></p> <p> 05.1000.0 50.00 Raw Brass FirUnico® universal built-in system. <i>Sistema incasso universale FirUnico®.</i></p>	<p>48.1010.8</p> <p>50.00 Stainless Steel</p>



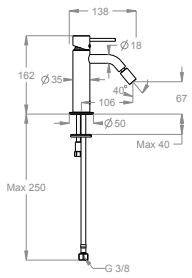

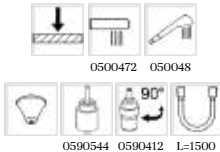
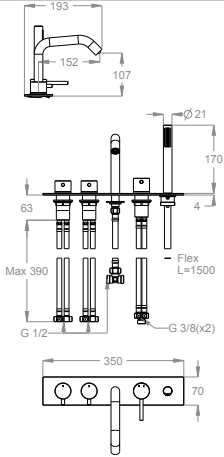


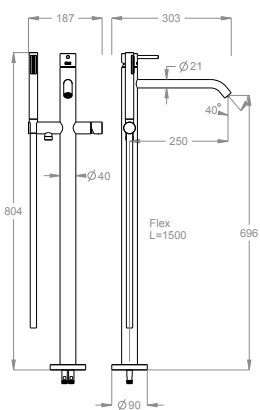

PHOTO / FOTO	DRAWING / DISEGNO	DESCRIPTION / DESCRIZIONE	Item / Finish Art. / Finitura
 		<p>CLEOSTEEL MINI - Bidet mixer, 162 mm high, center distance 106 mm long, without pop-up drain and hole for pull-rod.</p> <p><i>CLEOSTEEL MINI - Miscelatore bidet h. 162 mm, interasse 106 mm, senza scarico e senza foro per salterello.</i></p>	<p>48.2121.0</p> <p>50.00 Stainless Steel</p>
 		<p>Deck-mounted bath mixer with shower set.</p> <p><i>Gruppo bordo vasca al piano, con doccetta duplex.</i></p>	<p>48.3140.4</p> <p>50.00 Stainless Steel</p>
 		<p>External part for floor-mounted bath mixer with shower set.</p> <p><i>Parte esterna miscelatore bordo vasca a pavimento con doccetta duplex.</i></p> <p>Necessary complementary items <i>Articoli complementari necessari</i></p> <p> 05.2147.4 Built-in part for mixer. <i>Parte incasso miscelatore.</i></p> <p>50.00 Raw Brass</p>	<p>48.3300.8</p> <p>50.00 Stainless Steel</p>



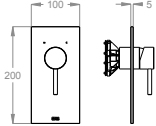



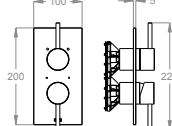



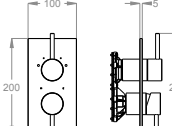



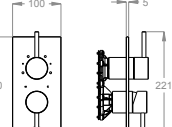


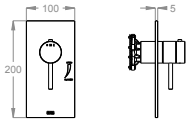



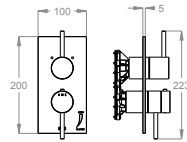



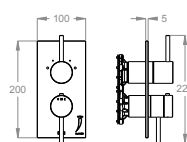



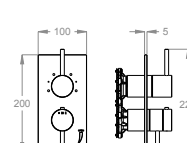


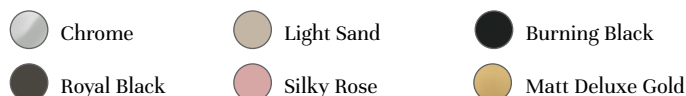
PHOTO / FOTO	DRAWING / DISEGNO	DESCRIPTION / DESCRIZIONE	Item / Finish Art. / Finitura
  <p>0590576 EN 817</p>		<p>External part for wall-mounted built-in one-way shower mixer.</p> <p><i>Parte esterna miscelatore doccia incasso a parete a una uscita.</i></p> <hr/> <p>Necessary complementary items <i>Articoli complementari necessari</i></p> <p> 05.1000.0 05.00 Raw Brass FirUnico® universal built-in system. <i>Sistema incasso universale FirUnico®.</i></p>	<p>48.5015.8</p> <hr/> <p>50.00 Stainless Steel</p>
  <p>0590576 0590575 EN 817</p>		<p>External part for wall-mounted built-in shower mixer with two-way diverter.</p> <p><i>Parte esterna miscelatore doccia incasso a parete con deviatore a due uscite.</i></p> <hr/> <p>Necessary complementary items <i>Articoli complementari necessari</i></p> <p> 05.1000.0 05.00 Raw Brass FirUnico® universal built-in system. <i>Sistema incasso universale FirUnico®.</i></p>	<p>48.5017.8</p> <hr/> <p>50.00 Stainless Steel</p>
  <p>0590576 0590577 EN 817</p>		<p>External part for wall-mounted built-in shower mixer with three-way diverter.</p> <p><i>Parte esterna miscelatore doccia incasso a parete con deviatore a tre uscite.</i></p> <hr/> <p>Necessary complementary items <i>Articoli complementari necessari</i></p> <p> 05.1000.0 05.00 Raw Brass FirUnico® universal built-in system. <i>Sistema incasso universale FirUnico®.</i></p>	<p>48.5018.8</p> <hr/> <p>50.00 Stainless Steel</p>
  <p>0590576 0590577 EN 817</p>		<p>External part for wall-mounted built-in shower mixer with four-way diverter.</p> <p><i>Parte esterna miscelatore doccia incasso a parete con deviatore a quattro uscite.</i></p> <hr/> <p>Necessary complementary items <i>Articoli complementari necessari</i></p> <p> 05.1000.0 05.00 Raw Brass FirUnico® universal built-in system. <i>Sistema incasso universale FirUnico®.</i></p>	<p>48.5019.8</p> <hr/> <p>50.00 Stainless Steel</p>

PHOTO / FOTO	DRAWING / DISEGNO	DESCRIPTION / DESCRIZIONE	Item / Finish Art./ Finitura
   <p>Thermo 0590581 EN 1111</p>		<p>External part for wall-mounted built-in thermostatic shower mixer with stop valve.</p> <p><i>Parte esterna miscelatore doccia incasso termostatico a parete con rubinetto d'arresto.</i></p> <p>Necessary complementary items <i>Articoli complementari necessari</i></p> <p> 05.1000.0 05.00 Raw Brass FirUnico® universal built-in system. <i>Sistema incasso universale FirUnico®.</i></p>	<p>48.8015.8</p> <p>50.00 Stainless Steel</p>
   <p>Thermo 0590581 0590575 EN 1111</p>		<p>External part for wall-mounted built-in thermostatic shower mixer with stop valve and two-way diverter.</p> <p><i>Parte esterna miscelatore doccia incasso termostatico a parete con rubinetto d'arresto e deviatore a due uscite.</i></p> <p>Necessary complementary items <i>Articoli complementari necessari</i></p> <p> 05.1000.0 05.00 Raw Brass FirUnico® universal built-in system. <i>Sistema incasso universale FirUnico®.</i></p>	<p>48.8017.8</p> <p>50.00 Stainless Steel</p>
   <p>Thermo 0590581 0590577 EN 1111</p>		<p>External part for wall-mounted built-in thermostatic shower mixer with stop valve and three-way diverter.</p> <p><i>Parte esterna miscelatore doccia incasso termostatico a parete con rubinetto d'arresto e deviatore a tre uscite.</i></p> <p>Necessary complementary items <i>Articoli complementari necessari</i></p> <p> 05.1000.0 05.00 Raw Brass FirUnico® universal built-in system. <i>Sistema incasso universale FirUnico®.</i></p>	<p>48.8018.8</p> <p>50.00 Stainless Steel</p>
   <p>Thermo 0590581 0590577 EN 1111</p>		<p>External part for wall-mounted built-in thermostatic shower mixer with stop valve and four-way diverter.</p> <p><i>Parte esterna miscelatore doccia incasso termostatico a parete con rubinetto d'arresto e deviatore a quattro uscite.</i></p> <p>Necessary complementary items <i>Articoli complementari necessari</i></p> <p> 05.1000.0 05.00 Raw Brass FirUnico® universal built-in system. <i>Sistema incasso universale FirUnico®.</i></p>	<p>48.8019.8</p> <p>50.00 Stainless Steel</p>

New Playone 90



The articles included in New Playone 90 collection are available in the following finishes:
Chrome, Light Sand, Burning Black, Royal Black, Silky Rose, Matt Deluxe Gold
 Gli articoli della collezione New Playone 90 sono disponibili nelle finiture:
Chrome, Light Sand, Burning Black, Royal Black, Silky Rose, Matt Deluxe Gold



TECHNICAL DATA / DATI TECNICI

65° (max 80° C)

Optimal hot water temperature
 Temperatura ottimale acqua calda


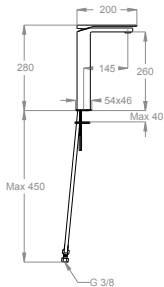
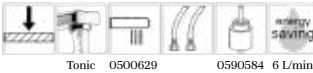

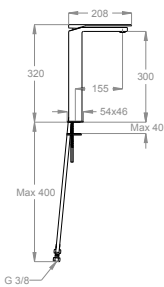

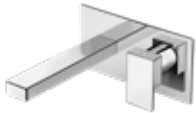
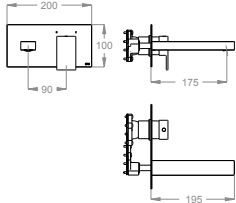

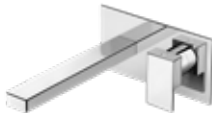
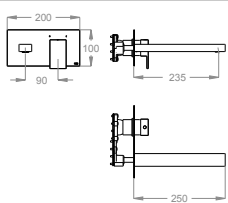

3 bar (min 1 - max 5)

Optimal operational pressure
 Pressione ottimale di esercizio

0,1 bar (max 1)

Hot/cold water pressure difference
 Differenza di pressione acqua calda/fredda

PHOTO / FOTO	DRAWING / DISEGNO	DESCRIPTION / DESCRIZIONE	Item / Finish Art./ Finitura
<p>Tonic 0500629 0590584 6 L/min</p>		<p>Wash basin mixer, 130 mm high, center distance 105 mm long, without pop-up drain and hole for pull-rod. <i>Miscelatore lavabo h. 130 mm, interasse 105 mm, senza scarico e senza foro per salterello.</i></p>	<p>90.1120.0</p> <p>10.00 Chrome 33.00 Light Sand 28.00 Burning Black 63.00 Royal Black 64.00 Silky Rose 45.00 Matt Deluxe Gold</p>
<p>Tonic 0500629 0590584 0410040 6 L/min</p>		<p>Wash basin mixer, 130 mm high, center distance 105 mm long, with pop-up drain and pull-rod. <i>Miscelatore lavabo h. 130 mm, interasse 105 mm, con scarico e salterello.</i></p>	<p>90.1120.1</p> <p>10.00 Chrome 33.00 Light Sand 28.00 Burning Black 63.00 Royal Black 64.00 Silky Rose 45.00 Matt Deluxe Gold</p>
<p>Tonic 0500629 0590584 6 L/min</p>		<p>Wash basin mixer, 130 mm high, center distance 130 mm long, without pop-up drain and hole for pull-rod. <i>Miscelatore lavabo h. 130 mm, interasse 130 mm, senza scarico e senza foro per salterello.</i></p>	<p>90.1130.0</p> <p>10.00 Chrome 33.00 Light Sand 28.00 Burning Black 63.00 Royal Black 64.00 Silky Rose 45.00 Matt Deluxe Gold</p>
<p>Tonic 0500629 0590584 0410040 6 L/min</p>		<p>Wash basin mixer, 130 mm high, center distance 130 mm long, with pop-up drain and pull-rod. <i>Miscelatore lavabo h. 130 mm, interasse 130 mm, con scarico e salterello.</i></p>	<p>90.1130.1</p> <p>10.00 Chrome 33.00 Light Sand 28.00 Burning Black 63.00 Royal Black 64.00 Silky Rose 45.00 Matt Deluxe Gold</p>

PHOTO / FOTO	DRAWING / DISEGNO	DESCRIPTION / DESCRIZIONE	Item / Finish Art./ Finitura
  		<p>Wash basin mixer with raised base, 280 mm high, center distance 145 mm long, without pop-up drain and hole for pull-rod.</p> <p><i>Miscelatore lavabo con prolunga h. 280 mm, interasse 145 mm, senza scarico e senza foro per salterello.</i></p>	<p>90.1140.0</p> <p>10.00 Chrome 33.00 Light Sand 28.00 Burning Black 63.00 Royal Black 64.00 Silky Rose 45.00 Matt Deluxe Gold</p>
  		<p>Wash basin mixer with raised base, 320 mm high, center distance 155 mm long, without pop-up drain and hole for pull-rod.</p> <p><i>Miscelatore lavabo con prolunga h. 320 mm, interasse 155 mm, senza scarico e senza foro per salterello.</i></p>	<p>90.1150.0</p> <p>10.00 Chrome 33.00 Light Sand 28.00 Burning Black 63.00 Royal Black 64.00 Silky Rose 45.00 Matt Deluxe Gold</p>
  		<p>External part for wall-mounted built-in basin mixer with plate, 195 mm long, center distance 175 mm long.</p> <p><i>Parte esterna miscelatore lavabo incasso a parete con piastra, lunghezza 195 mm, interasse 175 mm.</i></p> <p>Necessary complementary items <i>Articoli complementari necessari</i></p>	<p>90.1011.8</p> <p>10.00 Chrome 33.00 Light Sand 28.00 Burning Black 63.00 Royal Black 64.00 Silky Rose 45.00 Matt Deluxe Gold</p>
  		<p>External part for wall-mounted built-in basin mixer with plate, 250 mm long, center distance 235 mm long.</p> <p><i>Parte esterna miscelatore lavabo incasso a parete con piastra, lunghezza 250 mm, interasse 235 mm.</i></p> <p>Necessary complementary items <i>Articoli complementari necessari</i></p>	<p>90.1021.8</p> <p>10.00 Chrome 33.00 Light Sand 28.00 Burning Black 63.00 Royal Black 64.00 Silky Rose 45.00 Matt Deluxe Gold</p>



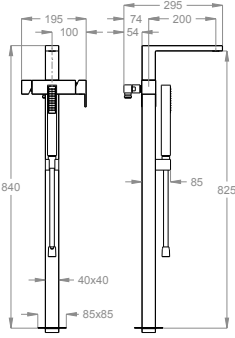



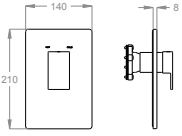



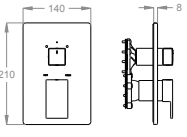

REMARKS / AVVERTENZE

For the single lever mixers FIR ITALIA recommends the assembling of removable filter elbow connections (Art. 11.0503.2, 11.0505.2) in order to avoid possible obstructions or damages to the cartridge caused by deposit conveyed by water.

Per i miscelatori monocomando FIR ITALIA consiglia l'installazione sulle due mandate di rubinetti filtro ispezionabili (Art. 11.0503.2, 11.0505.2), per trattenere eventuali corpi estranei che potrebbero danneggiare gli organi di tenuta della cartuccia.

New Playone 90

PHOTO / FOTO	DRAWING / DISEGNO	DESCRIPTION / DESCRIZIONE	Item / Finish Art./ Finitura
  <p>0500629 0590543 6 L/min</p>		<p>External part for floor-mounted wash basin mixer, 1050 mm high, centre distance 200 mm long.</p> <p><i>Parte esterna miscelatore lavabo a pavimento, h. 1050 mm, interasse 200 mm.</i></p> <p>Necessary complementary items <i>Articoli complementari necessari</i></p>  <p>05.2146.4 Built-in part for mixer. <i>Parte incasso miscelatore.</i></p> <p>05.00 Raw Brass</p>	<p>90.1300.8</p> <p>10.00 Chrome 33.00 Light Sand 28.00 Burning Black 63.00 Royal Black 64.00 Silky Rose 45.00 Matt Deluxe Gold</p>
  <p>Tonic 0500636 0590529 0410040</p>		<p>Bidet mixer, 130 mm high, center distance 113 mm long, with pop-up drain and pull-rod.</p> <p><i>Miscelatore bidet h. 130 mm, interasse 113 mm, con scarico e salterello.</i></p>	<p>90.2101.1</p> <p>10.00 Chrome 33.00 Light Sand 28.00 Burning Black 63.00 Royal Black 64.00 Silky Rose 45.00 Matt Deluxe Gold</p>
  <p>Tonic 0500624 0500713 0590401 0590546 L-1500</p>		<p>Five-hole deck-mounted bath mixer with diverter and shower set.</p> <p><i>Gruppo bordo vasca a cinque fori al piano, con deviatore e doccia duplex.</i></p>	<p>90.3140.4</p> <p>10.00 Chrome 33.00 Light Sand 28.00 Burning Black 63.00 Royal Black 64.00 Silky Rose 45.00 Matt Deluxe Gold</p>

PHOTO / FOTO	DRAWING / DISEGNO	DESCRIPTION / DESCRIZIONE	Item / Finish Art./ Finitura
 		<p>External part for floor-mounted bath mixer, with diverter and shower set.</p> <p><i>Parte esterna miscelatore bordo vasca a pavimento, con deviatore e doccetta duplex.</i></p> <p>Necessary complementary items <i>Articoli complementari necessari</i></p>  <p>05.2146.4 Built-in part for mixer. <i>Parte incasso miscelatore.</i></p> <p>05.00 Raw Brass</p>	<p>90.3301.8</p> <p>10.00 Chrome 33.00 Light Sand 28.00 Burning Black 63.00 Royal Black 64.00 Silky Rose 45.00 Matt Deluxe Gold</p>
 		<p>External part for wall-mounted built-in one-way shower mixer.</p> <p><i>Parte esterna miscelatore doccia incasso a parete a una uscita.</i></p> <p>Necessary complementary items <i>Articoli complementari necessari</i></p>  <p>05.1000.0 FirUnico® universal built-in system. <i>Sistema incasso universale FirUnico®.</i></p> <p>05.00 Raw Brass</p>	<p>90.5015.8</p> <p>10.00 Chrome 33.00 Light Sand 28.00 Burning Black 63.00 Royal Black 64.00 Silky Rose 45.00 Matt Deluxe Gold</p>
 		<p>External part for wall-mounted built-in shower mixer with two-way diverter.</p> <p><i>Parte esterna miscelatore doccia incasso a parete con deviatore a due uscite.</i></p> <p>Necessary complementary items <i>Articoli complementari necessari</i></p>  <p>05.1000.0 FirUnico® universal built-in system. <i>Sistema incasso universale FirUnico®.</i></p> <p>05.00 Raw Brass</p>	<p>90.5017.8</p> <p>10.00 Chrome 33.00 Light Sand 28.00 Burning Black 63.00 Royal Black 64.00 Silky Rose 45.00 Matt Deluxe Gold</p>

New Playone 90


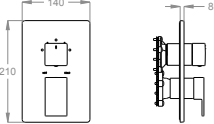



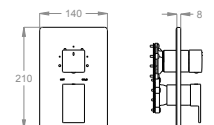



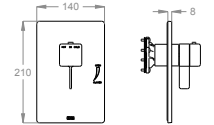



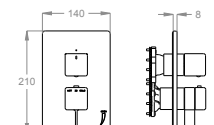



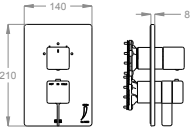



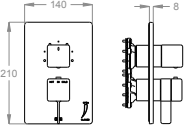



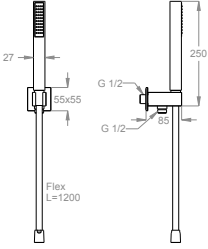

PHOTO / FOTO	DRAWING / DISEGNO	DESCRIPTION / DESCRIZIONE	Item / Finish Art./ Finitura
  		<p>External part for wall-mounted built-in shower mixer with three-way diverter. <i>Parte esterna miscelatore doccia incasso a parete con deviatore a tre uscite.</i></p> <p>Necessary complementary items <i>Articoli complementari necessari</i></p> <p> 05.1000.0 05.00 FirUnico® universal built-in system. Raw Brass <i>Sistema incasso universale FirUnico®.</i></p>	<p>90.5018.8</p> <p>10.00 Chrome 33.00 Light Sand 28.00 Burning Black 63.00 Royal Black 64.00 Silky Rose 45.00 Matt Deluxe Gold</p>
  		<p>External part for wall-mounted built-in shower mixer with four-way diverter. <i>Parte esterna miscelatore doccia incasso a parete con deviatore a quattro uscite.</i></p> <p>Necessary complementary items <i>Articoli complementari necessari</i></p> <p> 05.1000.0 05.00 FirUnico® universal built-in system. Raw Brass <i>Sistema incasso universale FirUnico®.</i></p>	<p>90.5019.8</p> <p>10.00 Chrome 33.00 Light Sand 28.00 Burning Black 63.00 Royal Black 64.00 Silky Rose 45.00 Matt Deluxe Gold</p>
  		<p>External part for wall-mounted built-in thermostatic shower mixer with stop valve. <i>Parte esterna miscelatore doccia incasso termostatico a parete con rubinetto d'arresto.</i></p> <p>Necessary complementary items <i>Articoli complementari necessari</i></p> <p> 05.1000.0 05.00 FirUnico® universal built-in system. Raw Brass <i>Sistema incasso universale FirUnico®.</i></p>	<p>85.8015.8</p> <p>10.00 Chrome 33.00 Light Sand 28.00 Burning Black 63.00 Royal Black 64.00 Silky Rose 45.00 Matt Deluxe Gold</p>
  		<p>External part for wall-mounted built-in thermostatic shower mixer with stop valve and two-way diverter. <i>Parte esterna miscelatore doccia incasso termostatico a parete con rubinetto d'arresto e deviatore a due uscite.</i></p> <p>Necessary complementary items <i>Articoli complementari necessari</i></p> <p> 05.1000.0 05.00 FirUnico® universal built-in system. Raw Brass <i>Sistema incasso universale FirUnico®.</i></p>	<p>85.8017.8</p> <p>10.00 Chrome 33.00 Light Sand 28.00 Burning Black 63.00 Royal Black 64.00 Silky Rose 45.00 Matt Deluxe Gold</p>

PHOTO / FOTO	DRAWING / DISEGNO	DESCRIPTION / DESCRIZIONE	Item / Finish Art./ Finitura
  		<p>External part for wall-mounted built-in thermostatic shower mixer with stop valve and three-way diverter.</p> <p><i>Parte esterna miscelatore doccia incasso termostatico a parete con rubinetto d'arresto e deviatore a tre uscite.</i></p> <hr/> <p>Necessary complementary items <i>Articoli complementari necessari</i></p> <p> 05.1000.0 05.00 FirUnico® universal built-in system. Raw Brass <i>Sistema incasso universale FirUnico®.</i></p>	<p>85.8018.8</p> <p>10.00 Chrome 33.00 Light Sand 28.00 Burning Black 63.00 Royal Black 64.00 Silky Rose 45.00 Matt Deluxe Gold</p>
  		<p>External part for wall-mounted built-in thermostatic shower mixer with stop valve and four-way diverter.</p> <p><i>Parte esterna miscelatore doccia incasso termostatico a parete con rubinetto d'arresto e deviatore a quattro uscite.</i></p> <hr/> <p>Necessary complementary items <i>Articoli complementari necessari</i></p> <p> 05.1000.0 05.00 FirUnico® universal built-in system. Raw Brass <i>Sistema incasso universale FirUnico®.</i></p>	<p>85.8019.8</p> <p>10.00 Chrome 33.00 Light Sand 28.00 Burning Black 63.00 Royal Black 64.00 Silky Rose 45.00 Matt Deluxe Gold</p>
  		<p>Built-in hand shower set with wall water inlet.</p> <p><i>Doccetta duplex incasso a parete con presa acqua.</i></p>	<p>90.0481.7</p> <p>10.00 Chrome 33.00 Light Sand 28.00 Burning Black 63.00 Royal Black 64.00 Silky Rose 45.00 Matt Deluxe Gold</p>

Synergy Stone 95





The articles included in Synergy Stone 95 collection are available in the following finishes:

Chrome+Glacier White Corian[®], Chrome+Deep Nocturne Corian[®], Burning Black+Deep Nocturne Corian[®], Royal Black+Deep Nocturne Corian[®], Silky Rose+Deep Nocturne Corian[®], Matt Deluxe Gold+Deep Nocturne Corian[®]
 Gli articoli della collezione Synergy Stone 95 sono disponibili nelle finiture:

Chrome+Glacier White Corian[®], Chrome+Deep Nocturne Corian[®], Burning Black+Deep Nocturne Corian[®], Royal Black+Deep Nocturne Corian[®], Silky Rose+Deep Nocturne Corian[®], Matt Deluxe Gold+Deep Nocturne Corian[®]

designed with
CORIAN[®]
 SOLID SURFACE

-  Chrome+Glacier White Corian[®]
-  Chrome+Deep Nocturne Corian[®]
-  Burning Black+Deep Nocturne Corian[®]
-  Royal Black+Deep Nocturne Corian[®]
-  Silky Rose+Deep Nocturne Corian[®]
-  Matt Deluxe Gold+Deep Nocturne Corian[®]

TECHNICAL DATA / DATI TECNICI

65° (max 80° C)


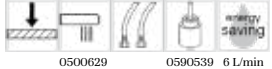
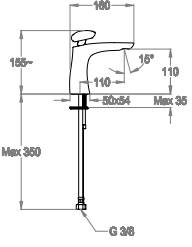


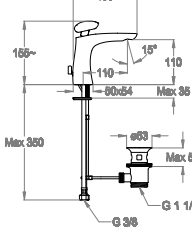


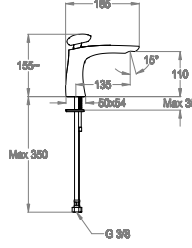
Optimal hot water temperature
 Temperatura ottimale acqua calda

3 bar (min 1 - max 5)



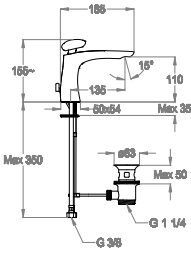

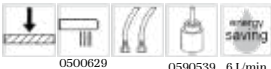
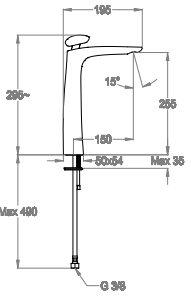


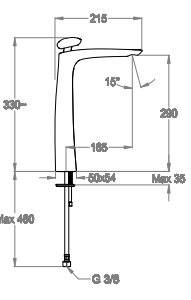


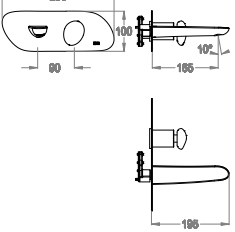

Optimal operational pressure
 Pressione ottimale di esercizio

0,1 bar (max 1)

Hot/cold water pressure difference
 Differenza di pressione acqua calda/fredda

PHOTO / FOTO	DRAWING / DISEGNO	DESCRIPTION / DESCRIZIONE	Item / Finish Art./ Finitura
  <p>0500629 0590539 6 L/min</p>		<p>Wash basin mixer, 155 mm high, center distance 110 mm long, without pop-up drain and hole for pull-rod.</p> <p>Miscelatore lavabo h. 155 mm, interasse 110 mm, senza scarico e senza foro per salterello.</p>	<p>95.1120.0</p> <p>10.20 Chrome+Glacier White Corian[®] 10.28 Chrome+Deep Nocturne Corian[®] 28.28 Burning Black+Deep Nocturne Corian[®] 63.28 Royal Black+Deep Nocturne Corian[®] 64.28 Silky Rose+Deep Nocturne Corian[®] 45.28 Matt Deluxe Gold+Deep Nocturne Corian[®]</p>
  <p>0500629 0590539 0410040 6 L/min</p>		<p>Wash basin mixer 155 mm high, center distance 110 mm long, with pop-up drain and pull-rod.</p> <p>Miscelatore lavabo h. 155 mm, interasse 110 mm, con scarico e salterello.</p>	<p>95.1120.1</p> <p>10.20 Chrome+Glacier White Corian[®] 10.28 Chrome+Deep Nocturne Corian[®] 28.28 Burning Black+Deep Nocturne Corian[®] 63.28 Royal Black+Deep Nocturne Corian[®] 64.28 Silky Rose+Deep Nocturne Corian[®] 45.28 Matt Deluxe Gold+Deep Nocturne Corian[®]</p>
  <p>0500629 0590539 6 L/min</p>		<p>Wash basin mixer, 155 mm high, center distance 135 mm long, without pop-up drain and hole for pull-rod.</p> <p>Miscelatore lavabo h. 155 mm, interasse 135 mm, senza scarico e senza foro per salterello.</p>	<p>95.1130.0</p> <p>10.20 Chrome+Glacier White Corian[®] 10.28 Chrome+Deep Nocturne Corian[®] 28.28 Burning Black+Deep Nocturne Corian[®] 63.28 Royal Black+Deep Nocturne Corian[®] 64.28 Silky Rose+Deep Nocturne Corian[®] 45.28 Matt Deluxe Gold+Deep Nocturne Corian[®]</p>

DuPont™, Corian® and the “designed with Corian®” logo are a trademark, a registered trademark and copyrighted material of E. I. du Pont de Nemours and Company or its affiliates.
 DuPont™, Corian® e il logo designed with Corian® sono un marchio commerciale, un marchio commerciale registrato e materiale protetto da copyright di E. I. du Pont de Nemours and Company o di sue società affiliate.

PHOTO / FOTO	DRAWING / DISEGNO	DESCRIPTION / DESCRIZIONE	Item / Finish Art./ Finitura
  <p>0500629 0590539 0410040 6 L/min</p>		<p>Wash basin mixer 155 mm high, center distance 135 mm long, with pop-up drain and pull-rod.</p> <p><i>Miscelatore lavabo h. 155 mm, interasse 135 mm, con scarico e salterello.</i></p>	<p>95.1130.1</p> <p>10.20 Chrome+Glacier White Corian® 10.28 Chrome+Deep Nocturne Corian® 28.28 Burning Black+Deep Nocturne Corian® 63.28 Royal Black+Deep Nocturne Corian® 64.28 Silky Rose+Deep Nocturne Corian® 45.28 Matt Deluxe Gold+Deep Nocturne Corian®</p>
  <p>0500629 0590539 6 L/min</p>		<p>Wash basin mixer, 295 mm high, center distance 150 mm long, without pop-up drain and hole for pull-rod.</p> <p><i>Miscelatore lavabo h. 295 mm, interasse 150 mm, senza scarico e senza foro per salterello.</i></p>	<p>95.1140.0</p> <p>10.20 Chrome+Glacier White Corian® 10.28 Chrome+Deep Nocturne Corian® 28.28 Burning Black+Deep Nocturne Corian® 63.28 Royal Black+Deep Nocturne Corian® 64.28 Silky Rose+Deep Nocturne Corian® 45.28 Matt Deluxe Gold+Deep Nocturne Corian®</p>
  <p>0500629 0590539 6 L/min</p>		<p>Wash basin mixer, 330 mm high, center distance 165 mm long, without pop-up drain and hole for pull-rod.</p> <p><i>Miscelatore lavabo h. 330 mm, interasse 165 mm, senza scarico e senza foro per salterello.</i></p>	<p>95.1150.0</p> <p>10.20 Chrome+Glacier White Corian® 10.28 Chrome+Deep Nocturne Corian® 28.28 Burning Black+Deep Nocturne Corian® 63.28 Royal Black+Deep Nocturne Corian® 64.28 Silky Rose+Deep Nocturne Corian® 45.28 Matt Deluxe Gold+Deep Nocturne Corian®</p>
  <p>0500629 0590576 6 L/min EN 817</p>		<p>External part for wall-mounted built-in basin mixer with plate, 195 mm long, center distance 165 mm long.</p> <p><i>Parte esterna miscelatore lavabo incasso a parete con piastra, lunghezza 195 mm, interasse 165 mm.</i></p> <p>Necessary complementary items <i>Articoli complementari necessari</i></p> <p> 05.1000.0 FirUnico® universal built-in system. <i>Sistema incasso universale FirUnico®.</i></p> <p>05.00 Raw Brass</p>	<p>95.1010.8</p> <p>10.20 Chrome+Glacier White Corian® 10.28 Chrome+Deep Nocturne Corian® 28.28 Burning Black+Deep Nocturne Corian® 63.28 Royal Black+Deep Nocturne Corian® 64.28 Silky Rose+Deep Nocturne Corian® 45.28 Matt Deluxe Gold+Deep Nocturne Corian®</p>

Synergy Stone 95



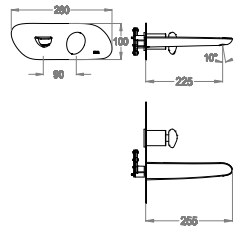


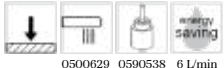
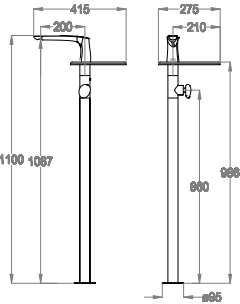



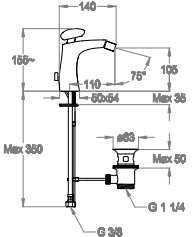


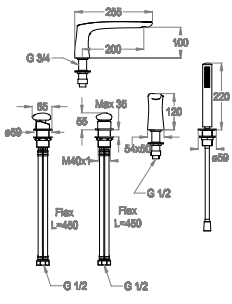

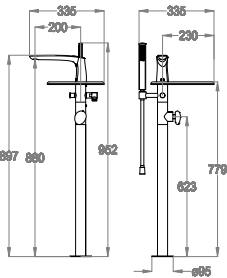



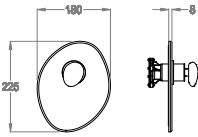







PHOTO / FOTO	DRAWING / DISEGNO	DESCRIPTION / DESCRIZIONE	Item / Finish Art./ Finitura
  <p>0500629 0590576 6 L/min EN 817</p>		<p>External part for wall-mounted built-in basin mixer with plate, 255 mm long, center distance 225 mm long. <i>Parte esterna miscelatore lavabo incasso a parete con piastra, lunghezza 255 mm, interasse 225 mm.</i></p> <p>Necessary complementary items <i>Articoli complementari necessari</i></p> <p> 05.1000.0 FirUnico® universal built-in system. / <i>Sistema incasso universale FirUnico®.</i> 05.00 Raw Brass</p>	<p>95.1020.8</p> <p>10.20 Chrome+Glacier White Corian® 10.28 Chrome+Deep Nocturne Corian® 28.28 Burning Black+Deep Nocturne Corian® 63.28 Royal Black+Deep Nocturne Corian® 64.28 Silky Rose+Deep Nocturne Corian® 45.28 Matt Deluxe Gold+Deep Nocturne Corian®</p>
  <p>0500629 0590538 6 L/min</p>		<p>External part for floor-mounted wash basin mixer, 1100 mm high, centre distance 200 mm long, with shelf in DuPont™ Corian®. <i>Parte esterna miscelatore lavabo a pavimento, h. 1100 mm, interasse 200 mm, con mensola portaoggetti in DuPont™ Corian®.</i></p> <p>Necessary complementary items <i>Articoli complementari necessari</i></p> <p> 05.2146.4 Built-in part for mixer. <i>Parte incasso miscelatore.</i> 05.00 Raw Brass</p>	<p>95.1300.8</p> <p>10.20 Chrome+Glacier White Corian® 10.28 Chrome+Deep Nocturne Corian® 28.28 Burning Black+Deep Nocturne Corian® 63.28 Royal Black+Deep Nocturne Corian® 64.28 Silky Rose+Deep Nocturne Corian® 45.28 Matt Deluxe Gold+Deep Nocturne Corian®</p>
  <p>0500636 0590539 0410040</p>		<p>Bidet mixer, 155 mm high, center distance 110 mm long, with pop-up drain and pull-rod. <i>Miscelatore bidet h. 155 mm, interasse 110 mm, con scarico e salterello.</i></p>	<p>95.2101.1</p> <p>10.20 Chrome+Glacier White Corian® 10.28 Chrome+Deep Nocturne Corian® 28.28 Burning Black+Deep Nocturne Corian® 63.28 Royal Black+Deep Nocturne Corian® 64.28 Silky Rose+Deep Nocturne Corian® 45.28 Matt Deluxe Gold+Deep Nocturne Corian®</p>
  <p>0500624 0500715 L=1500</p>		<p>Four-hole deck-mounted bath mixer with diverter and shower set. <i>Gruppo bordo vasca a quattro fori al piano, con deviatore e doccia duplex.</i></p>	<p>95.3140.4</p> <p>10.20 Chrome+Glacier White Corian® 10.28 Chrome+Deep Nocturne Corian® 28.28 Burning Black+Deep Nocturne Corian® 63.28 Royal Black+Deep Nocturne Corian® 64.28 Silky Rose+Deep Nocturne Corian® 45.28 Matt Deluxe Gold+Deep Nocturne Corian®</p>

PHOTO / FOTO	DRAWING / DISEGNO	DESCRIPTION / DESCRIZIONE	Item / Finish Art./ Finitura
  		<p>External part for floor-mounted bath mixer, with diverter, shower set and shelf in DuPont™ Corian®.</p> <p><i>Parte esterna miscelatore bordo vasca a pavimento, con deviatore, doccetta duplex e mensola portaoggetti in DuPont™ Corian®.</i></p> <p>Necessary complementary items <i>Articoli complementari necessari</i></p>  <p>05.2146.4 Built-in part for mixer. <i>Parte incasso miscelatore.</i></p> <p>05.00 Raw Brass</p>	<p>95.3300.8</p> <p>10.20 Chrome+Glacier White Corian® 10.28 Chrome+Deep Nocturne Corian® 28.28 Burning Black+Deep Nocturne Corian® 63.28 Royal Black+Deep Nocturne Corian® 64.28 Silky Rose+Deep Nocturne Corian® 45.28 Matt Deluxe Gold+Deep Nocturne Corian®</p>
  		<p>External part for wall-mounted built-in one-way shower mixer.</p> <p><i>Parte esterna miscelatore doccia incasso a parete a una uscita.</i></p> <p>Necessary complementary items <i>Articoli complementari necessari</i></p>  <p>05.1000.0 FirUnico® universal built-in system. / <i>Sistema incasso universale FirUnico®.</i></p> <p>05.00 Raw Brass</p>	<p>95.5015.8</p> <p>10.20 Chrome+Glacier White Corian® 10.28 Chrome+Deep Nocturne Corian® 28.28 Burning Black+Deep Nocturne Corian® 63.28 Royal Black+Deep Nocturne Corian® 64.28 Silky Rose+Deep Nocturne Corian® 45.28 Matt Deluxe Gold+Deep Nocturne Corian®</p>
  		<p>External part for wall-mounted built-in shower mixer with two-way diverter.</p> <p><i>Parte esterna miscelatore doccia incasso a parete con deviatore a due uscite.</i></p> <p>Necessary complementary items <i>Articoli complementari necessari</i></p>  <p>05.1000.0 FirUnico® universal built-in system. / <i>Sistema incasso universale FirUnico®.</i></p> <p>05.00 Raw Brass</p>	<p>95.5017.8</p> <p>10.20 Chrome+Glacier White Corian® 10.28 Chrome+Deep Nocturne Corian® 28.28 Burning Black+Deep Nocturne Corian® 63.28 Royal Black+Deep Nocturne Corian® 64.28 Silky Rose+Deep Nocturne Corian® 45.28 Matt Deluxe Gold+Deep Nocturne Corian®</p>
  		<p>External part for wall-mounted built-in shower mixer with three-way diverter.</p> <p><i>Parte esterna miscelatore doccia incasso a parete con deviatore a tre uscite.</i></p> <p>Necessary complementary items <i>Articoli complementari necessari</i></p>  <p>05.1000.0 FirUnico® universal built-in system. / <i>Sistema incasso universale FirUnico®.</i></p> <p>05.00 Raw Brass</p>	<p>95.5018.8</p> <p>10.20 Chrome+Glacier White Corian® 10.28 Chrome+Deep Nocturne Corian® 28.28 Burning Black+Deep Nocturne Corian® 63.28 Royal Black+Deep Nocturne Corian® 64.28 Silky Rose+Deep Nocturne Corian® 45.28 Matt Deluxe Gold+Deep Nocturne Corian®</p>

Synergy Stone 95


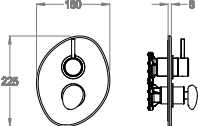



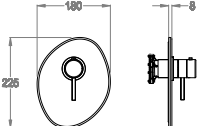



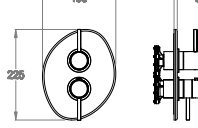



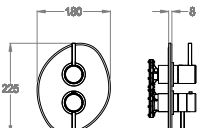



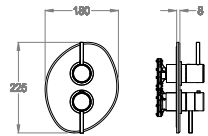



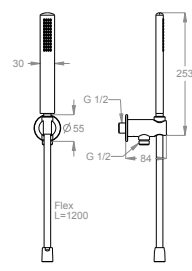

PHOTO / FOTO	DRAWING / DISEGNO	DESCRIPTION / DESCRIZIONE	Item / Finish Art./ Finitura
  		<p>External part for wall-mounted built-in shower mixer with four-way diverter.</p> <p><i>Parte esterna miscelatore doccia incasso a parete con deviatore a quattro uscite.</i></p> <p>Necessary complementary items <i>Articoli complementari necessari</i></p> <p> 05.1000.0 FirUnico® universal built-in system. / <i>Sistema incasso universale FirUnico®.</i> 05.00 Raw Brass</p>	<p>95.5019.8</p> <p>10.20 Chrome+Glacier White Corian® 10.28 Chrome+Deep Nocturne Corian® 28.28 Burning Black+Deep Nocturne Corian® 63.28 Royal Black+Deep Nocturne Corian® 64.28 Silky Rose+Deep Nocturne Corian® 45.28 Matt Deluxe Gold+Deep Nocturne Corian®</p>
  		<p>External part for wall-mounted built-in thermostatic shower mixer with stop valve.</p> <p><i>Parte esterna miscelatore doccia incasso termostatico a parete con rubinetto d'arresto.</i></p> <p>Necessary complementary items <i>Articoli complementari necessari</i></p> <p> 05.1000.0 FirUnico® universal built-in system. / <i>Sistema incasso universale FirUnico®.</i> 05.00 Raw Brass</p>	<p>93.8015.8</p> <p>10.00 Chrome 28.00 Burning Black 63.00 Royal Black 64.00 Silky Rose 45.00 Matt Deluxe Gold</p>
  		<p>External part for wall-mounted built-in thermostatic shower mixer with stop valve and two-way diverter.</p> <p><i>Parte esterna miscelatore doccia incasso termostatico a parete con rubinetto d'arresto e deviatore a due uscite.</i></p> <p>Necessary complementary items <i>Articoli complementari necessari</i></p> <p> 05.1000.0 FirUnico® universal built-in system. / <i>Sistema incasso universale FirUnico®.</i> 05.00 Raw Brass</p>	<p>93.8017.8</p> <p>10.00 Chrome 28.00 Burning Black 63.00 Royal Black 64.00 Silky Rose 45.00 Matt Deluxe Gold</p>
  		<p>External part for wall-mounted built-in thermostatic shower mixer with stop valve and three-way diverter.</p> <p><i>Parte esterna miscelatore doccia incasso termostatico a parete con rubinetto d'arresto e deviatore a tre uscite.</i></p> <p>Necessary complementary items <i>Articoli complementari necessari</i></p> <p> 05.1000.0 FirUnico® universal built-in system. / <i>Sistema incasso universale FirUnico®.</i> 05.00 Raw Brass</p>	<p>93.8018.8</p> <p>10.00 Chrome 28.00 Burning Black 63.00 Royal Black 64.00 Silky Rose 45.00 Matt Deluxe Gold</p>

PHOTO / FOTO	DRAWING / DISEGNO	DESCRIPTION / DESCRIZIONE	Item / Finish Art./ Finitura
  		<p>External part for wall-mounted built-in thermostatic shower mixer with stop valve and four-way diverter.</p> <p><i>Parte esterna miscelatore doccia incasso termostatico a parete con rubinetto d'arresto e deviatore a quattro uscite.</i></p> <hr/> <p>Necessary complementary items <i>Articoli complementari necessari</i></p> <p> 05.1000.0 FirUnico® universal built-in system. / <i>Sistema incasso universale FirUnico®.</i></p> <p>05.00 Raw Brass</p>	<p>93.8019.8</p> <p>10.00 Chrome 28.00 Burning Black 63.00 Royal Black 64.00 Silky Rose 45.00 Matt Deluxe Gold</p>
  		<p>Built-in hand shower set with wall water inlet.</p> <p><i>Doccetta duplex incasso a parete con presa acqua.</i></p>	<p>93.0481.7</p> <p>10.00 Chrome 28.00 Burning Black 63.00 Royal Black 64.00 Silky Rose 45.00 Matt Deluxe Gold</p>

REMARKS / AVVERTENZE

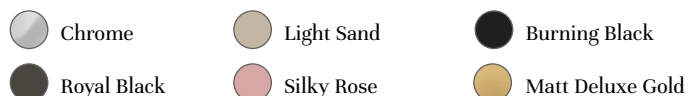
For the single lever mixers FIR ITALIA recommends the assembling of removable filter elbow connections (Art. 11.0503.2, 11.0505.2) in order to avoid possible obstructions or damages to the cartridge caused by deposit conveyed by water.

Per i miscelatori monocomando FIR ITALIA consiglia l'installazione sulle due mandate di rubinetti filtro ispezionabili (Art. 11.0503.2, 11.0505.2), per trattenere eventuali corpi estranei che potrebbero danneggiare gli organi di tenuta della cartuccia.

Kelio 63



The articles included in Kelio 63 collection are available in the following finishes:
Chrome, Light Sand, Burning Black, Royal Black, Silky Rose, Matt Deluxe Gold
 Gli articoli della collezione Kelio 63 sono disponibili nelle finiture:
Chrome, Light Sand, Burning Black, Royal Black, Silky Rose, Matt Deluxe Gold



TECHNICAL DATA / DATI TECNICI

65° (max 80° C)

Optimal hot water temperature
 Temperatura ottimale acqua calda


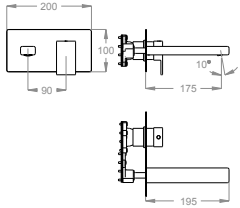



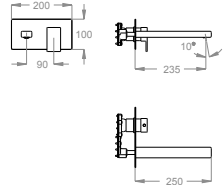



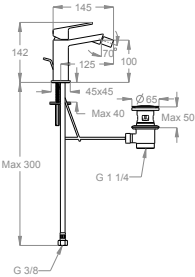
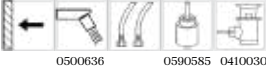

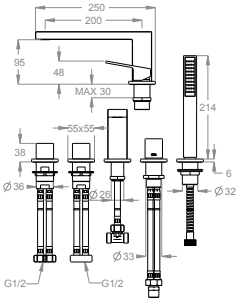
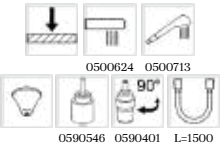
3 bar (min 1 - max 5)

Optimal operational pressure
 Pressione ottimale di esercizio

0,1 bar (max 1)

Hot/cold water pressure difference
 Differenza di pressione acqua calda/fredda

PHOTO / FOTO	DRAWING / DISEGNO	DESCRIPTION / DESCRIZIONE	Item / Finish Art./ Finitura
 0500629 0590585 6 L/min		<p>Wash basin mixer, 175 mm high, center distance 120 mm long, without pop-up drain and hole for pull-rod.</p> <p>Miscelatore lavabo h. 175 mm, interasse 120 mm, senza scarico e senza foro per salterello.</p>	<p>63.1120.0</p> <p>10.00 Chrome 33.00 Light Sand 28.00 Burning Black 63.00 Royal Black 64.00 Silky Rose 45.00 Matt Deluxe Gold</p>
 0500629 0590585 0410030 6 L/min		<p>Wash basin mixer 175 mm high, center distance 120 mm long, with pop-up drain and pull-rod.</p> <p>Miscelatore lavabo h. 175 mm, interasse 120 mm, con scarico e salterello.</p>	<p>63.1120.1</p> <p>10.00 Chrome 33.00 Light Sand 28.00 Burning Black 63.00 Royal Black 64.00 Silky Rose 45.00 Matt Deluxe Gold</p>
 0500629 0590585 6 L/min		<p>Wash basin mixer, 300 mm high, center distance 120 mm long, without pop-up drain and hole for pull-rod.</p> <p>Miscelatore lavabo h. 300 mm, interasse 120 mm, senza scarico e senza foro per salterello.</p>	<p>63.1140.0</p> <p>10.00 Chrome 33.00 Light Sand 28.00 Burning Black 63.00 Royal Black 64.00 Silky Rose 45.00 Matt Deluxe Gold</p>

PHOTO / FOTO	DRAWING / DISEGNO	DESCRIPTION / DESCRIZIONE	Item / Finish Art./ Finitura
  		<p>External part for wall-mounted built-in basin mixer with plate, 195 mm long, center distance 175 mm long.</p> <p><i>Parte esterna miscelatore lavabo incasso a parete con piastra, lunghezza 195 mm, interasse 175 mm.</i></p> <p>Necessary complementary items <i>Articoli complementari necessari</i></p> <p> 05.1000.0 05.00 FirUnico® universal built-in system. Raw Brass <i>Sistema incasso universale FirUnico®.</i></p>	<p>63.1010.8</p> <p>10.00 Chrome 33.00 Light Sand 28.00 Burning Black 63.00 Royal Black 64.00 Silky Rose 45.00 Matt Deluxe Gold</p>
  		<p>External part for wall-mounted built-in basin mixer with plate, 250 mm long, center distance 235 mm long.</p> <p><i>Parte esterna miscelatore lavabo incasso a parete con piastra, lunghezza 250 mm, interasse 235 mm.</i></p> <p>Necessary complementary items <i>Articoli complementari necessari</i></p> <p> 05.1000.0 05.00 FirUnico® universal built-in system. Raw Brass <i>Sistema incasso universale FirUnico®.</i></p>	<p>63.1020.8</p> <p>10.00 Chrome 33.00 Light Sand 28.00 Burning Black 63.00 Royal Black 64.00 Silky Rose 45.00 Matt Deluxe Gold</p>
  		<p>Bidet mixer, 142 mm high, center distance 125 mm long, with pop-up drain and pull-rod.</p> <p><i>Miscelatore bidet h. 142 mm, interasse 125 mm, con scarico e salterello.</i></p>	<p>63.2101.1</p> <p>10.00 Chrome 33.00 Light Sand 28.00 Burning Black 63.00 Royal Black 64.00 Silky Rose 45.00 Matt Deluxe Gold</p>
  		<p>Five-hole deck-mounted bath mixer with diverter and shower set.</p> <p><i>Gruppo bordo vasca a cinque fori al piano, con deviatore e doccia duplex.</i></p>	<p>63.3140.4</p> <p>10.00 Chrome 33.00 Light Sand 28.00 Burning Black 63.00 Royal Black 64.00 Silky Rose 45.00 Matt Deluxe Gold</p>

Kelio 63



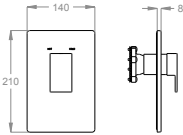



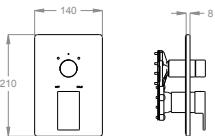



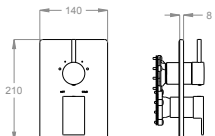



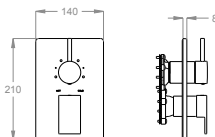


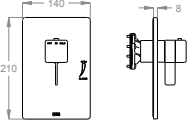



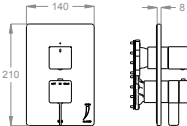



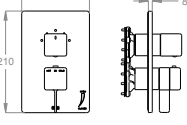



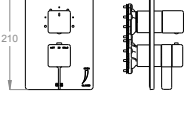



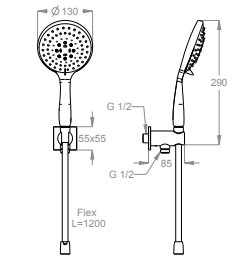

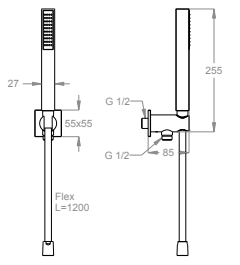
PHOTO / FOTO	DRAWING / DISEGNO	DESCRIPTION / DESCRIZIONE	Item / Finish Art./ Finitura
  <p>0590576</p>		<p>External part for wall-mounted built-in one-way shower mixer. <i>Parte esterna miscelatore doccia incasso a parete a una uscita.</i></p> <hr/> <p>Necessary complementary items <i>Articoli complementari necessari</i></p> <p> 05.1000.0 FirUnico® universal built-in system. / <i>Sistema incasso universale FirUnico®.</i> 05.00 Raw Brass</p>	<p>90.5015.8</p> <p>10.00 Chrome 33.00 Light Sand 28.00 Burning Black 63.00 Royal Black 64.00 Silky Rose 45.00 Matt Deluxe Gold</p>
  <p>0590576 0590574</p>		<p>External part for wall-mounted built-in shower mixer with two-way diverter. <i>Parte esterna miscelatore doccia incasso a parete con deviatore a due uscite.</i></p> <hr/> <p>Necessary complementary items <i>Articoli complementari necessari</i></p> <p> 05.1000.0 FirUnico® universal built-in system. / <i>Sistema incasso universale FirUnico®.</i> 05.00 Raw Brass</p>	<p>63.5017.8</p> <p>10.00 Chrome 33.00 Light Sand 28.00 Burning Black 63.00 Royal Black 64.00 Silky Rose 45.00 Matt Deluxe Gold</p>
  <p>0590576 0590577</p>		<p>External part for wall-mounted built-in shower mixer with three-way diverter. <i>Parte esterna miscelatore doccia incasso a parete con deviatore a tre uscite.</i></p> <hr/> <p>Necessary complementary items <i>Articoli complementari necessari</i></p> <p> 05.1000.0 FirUnico® universal built-in system. / <i>Sistema incasso universale FirUnico®.</i> 05.00 Raw Brass</p>	<p>63.5018.8</p> <p>10.00 Chrome 33.00 Light Sand 28.00 Burning Black 63.00 Royal Black 64.00 Silky Rose 45.00 Matt Deluxe Gold</p>
  <p>0590576 0590577</p>		<p>External part for wall-mounted built-in shower mixer with four-way diverter. <i>Parte esterna miscelatore doccia incasso a parete con deviatore a quattro uscite.</i></p> <hr/> <p>Necessary complementary items <i>Articoli complementari necessari</i></p> <p> 05.1000.0 FirUnico® universal built-in system. / <i>Sistema incasso universale FirUnico®.</i> 05.00 Raw Brass</p>	<p>63.5019.8</p> <p>10.00 Chrome 33.00 Light Sand 28.00 Burning Black 63.00 Royal Black 64.00 Silky Rose 45.00 Matt Deluxe Gold</p>

PHOTO / FOTO	DRAWING / DISEGNO	DESCRIPTION / DESCRIZIONE	Item / Finish Art./ Finitura
   <p>Thermo 0590581 EN 1111</p>		<p>External part for wall-mounted built-in thermostatic shower mixer with stop valve.</p> <p><i>Parte esterna miscelatore doccia incasso termostatico a parete con rubinetto d'arresto.</i></p> <hr/> <p>Necessary complementary items <i>Articoli complementari necessari</i></p> <p> 05.1000.0 FirUnico® universal built-in system. / <i>Sistema incasso universale FirUnico®.</i> 05.00 Raw Brass</p>	<p>85.8015.8</p> <p>10.00 Chrome 33.00 Light Sand 28.00 Burning Black 63.00 Royal Black 64.00 Silky Rose 45.00 Matt Deluxe Gold</p>
   <p>Thermo 0590581 0590575 EN 1111</p>		<p>External part for wall-mounted built-in thermostatic shower mixer with stop valve and two-way diverter.</p> <p><i>Parte esterna miscelatore doccia incasso termostatico a parete con rubinetto d'arresto e deviatore a due uscite.</i></p> <hr/> <p>Necessary complementary items <i>Articoli complementari necessari</i></p> <p> 05.1000.0 FirUnico® universal built-in system. / <i>Sistema incasso universale FirUnico®.</i> 05.00 Raw Brass</p>	<p>85.8017.8</p> <p>10.00 Chrome 33.00 Light Sand 28.00 Burning Black 63.00 Royal Black 64.00 Silky Rose 45.00 Matt Deluxe Gold</p>
   <p>Thermo 0590581 0590577 EN 1111</p>		<p>External part for wall-mounted built-in thermostatic shower mixer with stop valve and three-way diverter.</p> <p><i>Parte esterna miscelatore doccia incasso termostatico a parete con rubinetto d'arresto e deviatore a tre uscite.</i></p> <hr/> <p>Necessary complementary items <i>Articoli complementari necessari</i></p> <p> 05.1000.0 FirUnico® universal built-in system. / <i>Sistema incasso universale FirUnico®.</i> 05.00 Raw Brass</p>	<p>85.8018.8</p> <p>10.00 Chrome 33.00 Light Sand 28.00 Burning Black 63.00 Royal Black 64.00 Silky Rose 45.00 Matt Deluxe Gold</p>
   <p>Thermo 0590581 0590577 EN 1111</p>		<p>External part for wall-mounted built-in thermostatic shower mixer with stop valve and four-way diverter.</p> <p><i>Parte esterna miscelatore doccia incasso termostatico a parete con rubinetto d'arresto e deviatore a quattro uscite.</i></p> <hr/> <p>Necessary complementary items <i>Articoli complementari necessari</i></p> <p> 05.1000.0 FirUnico® universal built-in system. / <i>Sistema incasso universale FirUnico®.</i> 05.00 Raw Brass</p>	<p>85.8019.8</p> <p>10.00 Chrome 33.00 Light Sand 28.00 Burning Black 63.00 Royal Black 64.00 Silky Rose 45.00 Matt Deluxe Gold</p>

Kelio 63

PHOTO / FOTO	DRAWING / DISEGNO	DESCRIPTION / DESCRIZIONE	Item / Finish Art./ Finitura
		<p>Built-in hand shower set with multifunctional hand shower and wall water inlet.</p> <p><i>Doccetta multifunzione incasso a parete con presa acqua.</i></p>	<p>44.0481.6</p> <p>10.00 Chrome 33.00 Light Sand 28.00 Burning Black 63.00 Royal Black 64.00 Silky Rose 45.00 Matt Deluxe Gold</p>
		<p>Built-in hand shower set with wall water inlet.</p> <p><i>Doccetta duplex incasso a parete con presa acqua.</i></p>	<p>44.0481.7</p> <p>10.00 Chrome 33.00 Light Sand 28.00 Burning Black 63.00 Royal Black 64.00 Silky Rose 45.00 Matt Deluxe Gold</p>

REMARKS / AVVERTENZE

For the single lever mixers FIR ITALIA recommends the assembling of removable filter elbow connections (Art. 11.0503.2, 11.0505.2) in order to avoid possible obstructions or damages to the cartridge caused by deposit conveyed by water.

Per i miscelatori monocomando FIR ITALIA consiglia l'installazione sulle due mandate di rubinetti filtro ispezionabili (Art. 11.0503.2, 11.0505.2), per trattenere eventuali corpi estranei che potrebbero danneggiare gli organi di tenuta della cartuccia.

Doda 67



The articles included in Doda 67 collection are available in the following finishings:
Chrome, Light Sand, Burning Black, Royal Black, Silky Rose, Matt Deluxe Gold
 Gli articoli della collezione Doda 67 sono disponibili nelle finiture sotto indicate:
Chrome, Light Sand, Burning Black, Royal Black, Silky Rose, Matt Deluxe Gold



TECHNICAL DATA / DATI TECNICI

65° (max 80° C)

Optimal hot water temperature
 Temperatura ottimale acqua calda

3 bar (min 1 - max 5)

Optimal operational pressure
 Pressione ottimale di esercizio

0,1 bar (max 1)

Hot/cold water pressure difference
 Differenza di pressione acqua calda/fredda



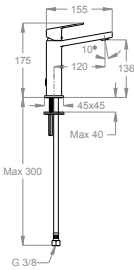


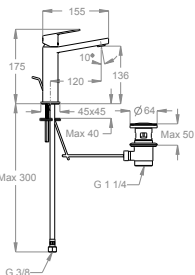


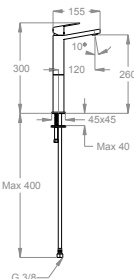
PHOTO / FOTO	DRAWING / DISEGNO	DESCRIPTION / DESCRIZIONE	Item / Finish Art./ Finitura
  <p>0500629 0590585 6 L/min</p>		<p>Wash basin mixer, 175 mm high, center distance 120 mm long, without pop-up drain and hole for pull-rod. <i>Miscelatore lavabo h. 175 mm, interasse 120 mm, senza scarico e senza foro per salterello.</i></p>	<p>67.1120.0</p> <p>10.00 Chrome 33.00 Light Sand 28.00 Burning Black 63.00 Royal Black 64.00 Silky Rose 45.00 Matt Deluxe Gold</p>
  <p>0500629 0590585 0410030 6 L/min</p>		<p>Wash basin mixer 175 mm high, center distance 120 mm long, with pop-up drain and pull-rod. <i>Miscelatore lavabo h. 175 mm, interasse 120 mm, con scarico e salterello.</i></p>	<p>67.1120.1</p> <p>10.00 Chrome 33.00 Light Sand 28.00 Burning Black 63.00 Royal Black 64.00 Silky Rose 45.00 Matt Deluxe Gold</p>
  <p>0500629 0590585 6 L/min</p>		<p>Wash basin mixer, 300 mm high, center distance 120 mm long, without pop-up drain and hole for pull-rod. <i>Miscelatore lavabo h. 300 mm, interasse 120 mm, senza scarico e senza foro per salterello.</i></p>	<p>67.1140.0</p> <p>10.00 Chrome 33.00 Light Sand 28.00 Burning Black 63.00 Royal Black 64.00 Silky Rose 45.00 Matt Deluxe Gold</p>



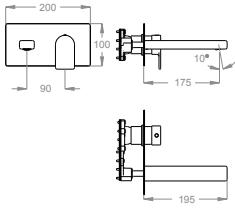



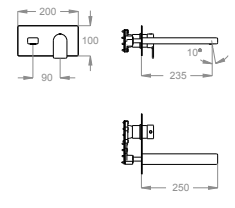


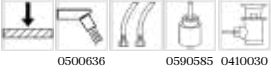
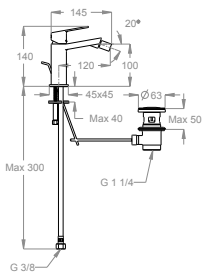

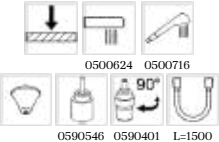
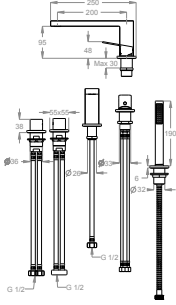
PHOTO / FOTO	DRAWING / DISEGNO	DESCRIPTION / DESCRIZIONE	Item / Finish Art./ Finitura
  <p>0500629 0590576 6 L/min</p>		<p>External part for wall-mounted built-in basin mixer with plate, 195 mm long, center distance 175 mm long. <i>Parte esterna miscelatore lavabo incasso a parete con piastra, lunghezza 195 mm, interasse 175 mm.</i></p> <p>Necessary complementary items <i>Articoli complementari necessari</i></p> <p> 05.1000.0 FirUnico® universal built-in system. / <i>Sistema incasso universale FirUnico®.</i> 05.00 Raw Brass</p>	<p>67.1010.8</p> <p>10.00 Chrome 33.00 Light Sand 28.00 Burning Black 63.00 Royal Black 64.00 Silky Rose 45.00 Matt Deluxe Gold</p>
  <p>0500629 0590576 6 L/min</p>		<p>External part for wall-mounted built-in basin mixer with plate, 250 mm long, center distance 235 mm long. <i>Parte esterna miscelatore lavabo incasso a parete con piastra, lunghezza 250 mm, interasse 235 mm.</i></p> <p>Necessary complementary items <i>Articoli complementari necessari</i></p> <p> 05.1000.0 FirUnico® universal built-in system. / <i>Sistema incasso universale FirUnico®.</i> 05.00 Raw Brass</p>	<p>67.1020.8</p> <p>10.00 Chrome 33.00 Light Sand 28.00 Burning Black 63.00 Royal Black 64.00 Silky Rose 45.00 Matt Deluxe Gold</p>
  <p>0500636 0590585 0410030</p>		<p>Bidet mixer, 140 mm high, center distance 120 mm long, with pop-up drain and pull-rod. <i>Miscelatore bidet h. 140 mm, interasse 120 mm, con scarico e salterello.</i></p>	<p>67.2101.1</p> <p>10.00 Chrome 33.00 Light Sand 28.00 Burning Black 63.00 Royal Black 64.00 Silky Rose 45.00 Matt Deluxe Gold</p>
  <p>0500624 0500716 0590546 0590401 L-1500</p>		<p>Five-hole deck-mounted bath mixer with diverter and shower set. <i>Gruppo bordo vasca a cinque fori al piano, con deviatore e doccetta duplex.</i></p>	<p>67.3140.4</p> <p>10.00 Chrome 33.00 Light Sand 28.00 Burning Black 63.00 Royal Black 64.00 Silky Rose 45.00 Matt Deluxe Gold</p>




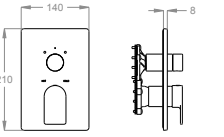

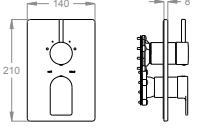
PHOTO / FOTO	DRAWING / DISEGNO	DESCRIPTION / DESCRIZIONE	Item / Finish Art./ Finitura
  0590576		<p>External part for wall-mounted built-in one-way shower mixer.</p> <p><i>Parte esterna miscelatore doccia incasso a parete a una uscita.</i></p> <hr/> <p>Necessary complementary items <i>Articoli complementari necessari</i></p> <p> 05.1000.0 FirUnico® universal built-in system. / <i>Sistema incasso universale FirUnico®.</i> 05.00 Raw Brass</p>	<p>67.5015.8</p> <p>10.00 Chrome 33.00 Light Sand 28.00 Burning Black 63.00 Royal Black 64.00 Silky Rose 45.00 Matt Deluxe Gold</p>
  0590576 0590574		<p>External part for wall-mounted built-in shower mixer with two-way diverter.</p> <p><i>Parte esterna miscelatore doccia incasso a parete con deviatore a due uscite.</i></p> <hr/> <p>Necessary complementary items <i>Articoli complementari necessari</i></p> <p> 05.1000.0 FirUnico® universal built-in system. / <i>Sistema incasso universale FirUnico®.</i> 05.00 Raw Brass</p>	<p>67.5017.8</p> <p>10.00 Chrome 33.00 Light Sand 28.00 Burning Black 63.00 Royal Black 64.00 Silky Rose 45.00 Matt Deluxe Gold</p>
  0590576 0590577		<p>External part for wall-mounted built-in shower mixer with three-way diverter.</p> <p><i>Parte esterna miscelatore doccia incasso a parete con deviatore a tre uscite.</i></p> <hr/> <p>Necessary complementary items <i>Articoli complementari necessari</i></p> <p> 05.1000.0 FirUnico® universal built-in system. / <i>Sistema incasso universale FirUnico®.</i> 05.00 Raw Brass</p>	<p>67.5018.8</p> <p>10.00 Chrome 33.00 Light Sand 28.00 Burning Black 63.00 Royal Black 64.00 Silky Rose 45.00 Matt Deluxe Gold</p>
  0590576 0590577		<p>External part for wall-mounted built-in shower mixer with four-way diverter.</p> <p><i>Parte esterna miscelatore doccia incasso a parete con deviatore a quattro uscite.</i></p> <hr/> <p>Necessary complementary items <i>Articoli complementari necessari</i></p> <p> 05.1000.0 FirUnico® universal built-in system. / <i>Sistema incasso universale FirUnico®.</i> 05.00 Raw Brass</p>	<p>67.5019.8</p> <p>10.00 Chrome 33.00 Light Sand 28.00 Burning Black 63.00 Royal Black 64.00 Silky Rose 45.00 Matt Deluxe Gold</p>

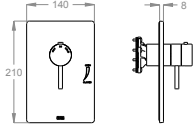



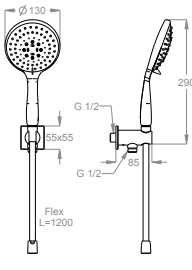

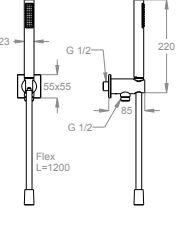
PHOTO / FOTO	DRAWING / DISEGNO	DESCRIPTION / DESCRIZIONE	Item / Finish Art./ Finitura
  		<p>External part for wall-mounted built-in thermostatic shower mixer with stop valve. <i>Parte esterna miscelatore doccia incasso termostatico a parete con rubinetto d'arresto.</i></p> <p>Necessary complementary items <i>Articoli complementari necessari</i></p> <p> 05.1000.0 FirUnico® universal built-in system. / <i>Sistema incasso universale FirUnico®.</i> 05.00 Raw Brass</p>	<p>88.8015.8</p> <p>10.00 Chrome 33.00 Light Sand 28.00 Burning Black 63.00 Royal Black 64.00 Silky Rose 45.00 Matt Deluxe Gold</p>
  		<p>External part for wall-mounted built-in thermostatic shower mixer with stop valve and two-way diverter. <i>Parte esterna miscelatore doccia incasso termostatico a parete con rubinetto d'arresto e deviatore a due uscite.</i></p> <p>Necessary complementary items <i>Articoli complementari necessari</i></p> <p> 05.1000.0 FirUnico® universal built-in system. / <i>Sistema incasso universale FirUnico®.</i> 05.00 Raw Brass</p>	<p>88.8017.8</p> <p>10.00 Chrome 33.00 Light Sand 28.00 Burning Black 63.00 Royal Black 64.00 Silky Rose 45.00 Matt Deluxe Gold</p>
  		<p>External part for wall-mounted built-in thermostatic shower mixer with stop valve and three-way diverter. <i>Parte esterna miscelatore doccia incasso termostatico a parete con rubinetto d'arresto e deviatore a tre uscite.</i></p> <p>Necessary complementary items <i>Articoli complementari necessari</i></p> <p> 05.1000.0 FirUnico® universal built-in system. / <i>Sistema incasso universale FirUnico®.</i> 05.00 Raw Brass</p>	<p>88.8018.8</p> <p>10.00 Chrome 33.00 Light Sand 28.00 Burning Black 63.00 Royal Black 64.00 Silky Rose 45.00 Matt Deluxe Gold</p>
  		<p>External part for wall-mounted built-in thermostatic shower mixer with stop valve and four-way diverter. <i>Parte esterna miscelatore doccia incasso termostatico a parete con rubinetto d'arresto e deviatore a quattro uscite.</i></p> <p>Necessary complementary items <i>Articoli complementari necessari</i></p> <p> 05.1000.0 FirUnico® universal built-in system. / <i>Sistema incasso universale FirUnico®.</i> 05.00 Raw Brass</p>	<p>88.8019.8</p> <p>10.00 Chrome 33.00 Light Sand 28.00 Burning Black 63.00 Royal Black 64.00 Silky Rose 45.00 Matt Deluxe Gold</p>

PHOTO / FOTO	DRAWING / DISEGNO	DESCRIPTION / DESCRIZIONE	Item / Finish Art./ Finitura
 <p>L-1200 0540933</p>		<p>Built-in hand shower set with multifunctional hand shower and wall water inlet. <i>Doccetta multifunzione incasso a parete con presa acqua.</i></p>	<p>44.0481.6</p> <p>10.00 Chrome 33.00 Light Sand 28.00 Burning Black 63.00 Royal Black 64.00 Silky Rose 45.00 Matt Deluxe Gold</p>
 <p>L-1200</p>		<p>Built-in hand shower set with wall water inlet. <i>Doccetta duplex incasso a parete con presa acqua.</i></p>	<p>67.0481.7</p> <p>10.00 Chrome 33.00 Light Sand 28.00 Burning Black 63.00 Royal Black 64.00 Silky Rose 45.00 Matt Deluxe Gold</p>

REMARKS / AVVERTENZE

For the single lever mixers FIR ITALIA recommends the assembling of removable filter elbow connections (Art. 11.0503.2, 11.0505.2) in order to avoid possible obstructions or damages to the cartridge caused by deposit conveyed by water.

Per i miscelatori monocomando FIR ITALIA consiglia l'installazione sulle due mandate di rubinetti filtro ispezionabili (Art. 11.0503.2, 11.0505.2), per trattenere eventuali corpi estranei che potrebbero danneggiare gli organi di tenuta della cartuccia.

Showers



The articles included in Showers collection are available in the following finishes:

Chrome, Chrome+Glacier White Corian[®], Chrome+Deep Nocturne Corian[®], Light Sand, Burning Black, Burning Black+Deep Nocturne Corian[®], Royal Black, Royal Black+Deep Nocturne Corian[®], Silky Rose, Silky Rose+Deep Nocturne Corian[®], Matt Deluxe Gold, Matt Deluxe Gold+Deep Nocturne Corian[®], Stainless Steel

Gli articoli della collezione Showers sono disponibili nelle finiture:

Chrome, Chrome+Glacier White Corian[®], Chrome+Deep Nocturne Corian[®], Light Sand, Burning Black, Burning Black+Deep Nocturne Corian[®], Royal Black, Royal Black+Deep Nocturne Corian[®], Silky Rose, Silky Rose+Deep Nocturne Corian[®], Matt Deluxe Gold, Matt Deluxe Gold+Deep Nocturne Corian[®], Stainless Steel

designed with
CORIAN[®]
SOLID SURFACE

- | | | |
|---|--|--|
|  Chrome |  Light Sand |  Burning Black |
|  Royal Black |  Silky Rose |  Matt Deluxe Gold |
|  Chrome+Glacier White Corian [®] |  Chrome+Deep Nocturne Corian [®] | |
|  Burning Black+Deep Nocturne Corian [®] |  Royal Black+Deep Nocturne Corian [®] | |
|  Silky Rose+Deep Nocturne Corian [®] |  Matt Deluxe Gold+Deep Nocturne Corian [®] | |
|  AISI 316L stainless steel/acciaio inossidabile | | |

TECHNICAL DATA / DATI TECNICI

65° (max 80° C)



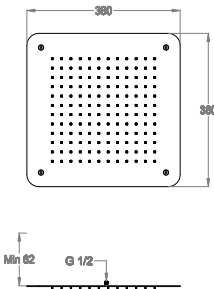



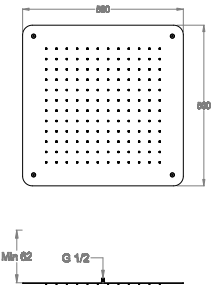

Optimal hot water temperature
Temperatura ottimale acqua calda

3 bar (min 1 - max 5)



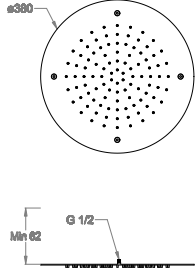



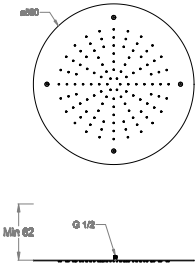



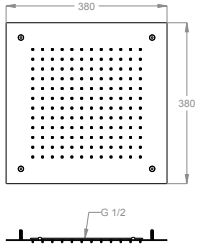



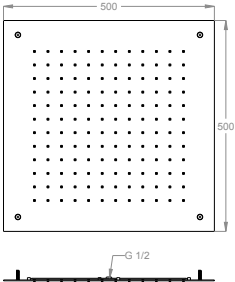

Optimal operational pressure
Pressione ottimale di esercizio

0,1 bar (max 1)

Hot/cold water pressure difference
Differenza di pressione acqua calda/fredda

PHOTO / FOTO	DRAWING / DISEGNO	DESCRIPTION / DESCRIZIONE	Item / Finish Art./ Finitura
 		<p>External part for built-in ceiling-mounted stainless steel shower head 380x380 mm. <i>Parte esterna soffione doccia incasso a soffitto 380x380 mm in acciaio inox.</i></p> <p>Necessary complementary items <i>Articoli complementari necessari</i></p> <p>05.2449.2</p> <p> Built-in part for ceiling-mounted shower head. 00.00 <i>Parte incasso soffione doccia incasso a soffitto.</i> Natural Color</p>	<p>85.7240.8</p> <p>10.00 Chrome 33.00 Light Sand 28.00 Burning Black 63.00 Royal Black 64.00 Silky Rose 45.00 Matt Deluxe Gold</p>
 		<p>External part for built-in ceiling-mounted stainless steel shower head 500x500 mm. <i>Parte esterna soffione doccia incasso a soffitto 500x500 mm in acciaio inox.</i></p> <p>Necessary complementary items <i>Articoli complementari necessari</i></p> <p>05.2449.3</p> <p> Built-in part for ceiling-mounted shower head. 00.00 <i>Parte incasso soffione doccia incasso a soffitto.</i> Natural Color</p>	<p>85.7245.8</p> <p>10.00 Chrome 33.00 Light Sand 28.00 Burning Black 63.00 Royal Black 64.00 Silky Rose 45.00 Matt Deluxe Gold</p>

DuPont™, Corian® and the “designed with Corian®” logo are a trademark, a registered trademark and copyrighted material of E. I. du Pont de Nemours and Company or its affiliates. DuPont™, Corian® e il logo designed with Corian® sono un marchio commerciale, un marchio commerciale registrato e materiale protetto da copyright di E. I. du Pont de Nemours and Company o di sue società affiliate.

PHOTO / FOTO	DRAWING / DISEGNO	DESCRIPTION / DESCRIZIONE	Item / Finish Art./ Finitura
  <p>ø 380 102 8 L/min</p>		<p>External part for built-in ceiling-mounted stainless steel shower head ø 380 mm. <i>Parte esterna soffione doccia incasso a soffitto ø 380 mm in acciaio inox.</i></p> <p>Necessary complementary items <i>Articoli complementari necessari</i></p> <p>05.2449.4</p> <p> Built-in part for ceiling-mounted shower head. 00.00 <i>Parte incasso soffione doccia incasso a soffitto.</i> Natural Color</p>	<p>84.7216.8</p> <p>10.00 Chrome 33.00 Light Sand 28.00 Burning Black 63.00 Royal Black 64.00 Silky Rose 45.00 Matt Deluxe Gold</p>
  <p>ø 500 114 9 L/min</p>		<p>External part for built-in ceiling-mounted stainless steel shower head ø 500 mm. <i>Parte esterna soffione doccia incasso a soffitto ø 500 mm in acciaio inox.</i></p> <p>Necessary complementary items <i>Articoli complementari necessari</i></p> <p>05.2449.5</p> <p> Built-in part for ceiling-mounted shower head. 00.00 <i>Parte incasso soffione doccia incasso a soffitto.</i> Natural Color</p>	<p>84.7219.8</p> <p>10.00 Chrome 33.00 Light Sand 28.00 Burning Black 63.00 Royal Black 64.00 Silky Rose 45.00 Matt Deluxe Gold</p>
  <p>380x380 144 7 L/min</p>		<p>External part for built-in ceiling-mounted stainless steel shower head 380x380 mm. <i>Parte esterna soffione doccia incasso a soffitto 380x380 mm in acciaio inox.</i></p> <p>Necessary complementary items <i>Articoli complementari necessari</i></p> <p>05.2449.2</p> <p> Built-in part for ceiling-mounted shower head. 00.00 <i>Parte incasso soffione doccia incasso a soffitto.</i> Natural Color</p>	<p>85.7241.8</p> <p>50.00 Stainless Steel</p>
  <p>500x500 144 9 L/min</p>		<p>External part for built-in ceiling-mounted stainless steel shower head 500x500 mm. <i>Parte esterna soffione doccia incasso a soffitto 500x500 mm in acciaio inox.</i></p> <p>Necessary complementary items <i>Articoli complementari necessari</i></p> <p>05.2449.3</p> <p> Built-in part for ceiling-mounted shower head. 00.00 <i>Parte incasso soffione doccia incasso a soffitto.</i> Natural Color</p>	<p>85.7246.8</p> <p>50.00 Stainless Steel</p>

Showers


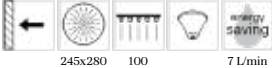
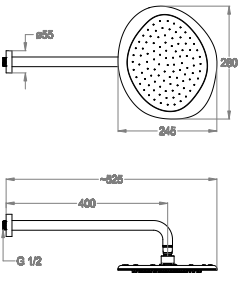

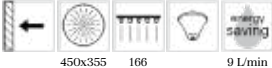
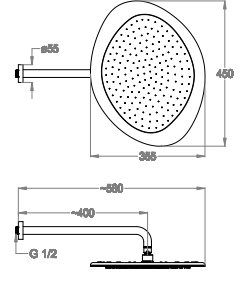

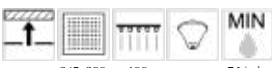
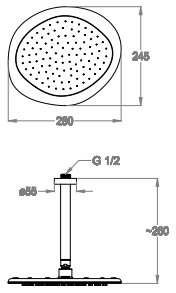


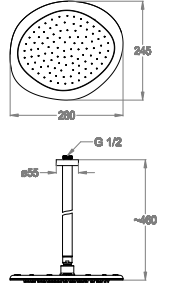


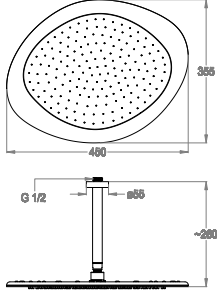


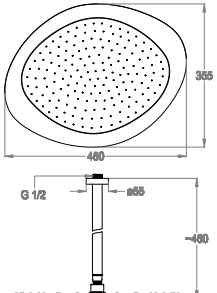
PHOTO / FOTO	DRAWING / DISEGNO	DESCRIPTION / DESCRIZIONE	Item / Finish Art. / Finitura
  <p>245x280 100 7 L/min</p>		<p>Wall-mounted shower head 280x245 mm. Soffione doccia a parete 280x245 mm.</p>	<p>93.7093.4</p> <p>10.20 Chrome+Glacier White Corian® 10.28 Chrome+Deep Nocturne Corian® 28.28 Burning Black+Deep Nocturne Corian® 63.28 Royal Black+Deep Nocturne Corian® 64.28 Silky Rose+Deep Nocturne Corian® 45.28 Matt Deluxe Gold+Deep Nocturne Corian®</p>
  <p>450x355 166 9 L/min</p>		<p>Wall-mounted shower head 450x355 mm. Soffione doccia a parete 450x355 mm.</p>	<p>93.7095.4</p> <p>10.20 Chrome+Glacier White Corian® 10.28 Chrome+Deep Nocturne Corian® 28.28 Burning Black+Deep Nocturne Corian® 63.28 Royal Black+Deep Nocturne Corian® 64.28 Silky Rose+Deep Nocturne Corian® 45.28 Matt Deluxe Gold+Deep Nocturne Corian®</p>
  <p>245x280 100 7 L/min</p>		<p>Ceiling-mounted shower head 280x245 mm, 260 mm high. Soffione doccia a soffitto 280x245 mm, h. 260 mm.</p>	<p>93.7093.6</p> <p>10.20 Chrome+Glacier White Corian® 10.28 Chrome+Deep Nocturne Corian® 28.28 Burning Black+Deep Nocturne Corian® 63.28 Royal Black+Deep Nocturne Corian® 64.28 Silky Rose+Deep Nocturne Corian® 45.28 Matt Deluxe Gold+Deep Nocturne Corian®</p>
  <p>245x280 100 7 L/min</p>		<p>Ceiling-mounted shower head 280x245 mm, 460 mm high. Soffione doccia a soffitto 280x245 mm, h. 460 mm.</p>	<p>93.7093.8</p> <p>10.20 Chrome+Glacier White Corian® 10.28 Chrome+Deep Nocturne Corian® 28.28 Burning Black+Deep Nocturne Corian® 63.28 Royal Black+Deep Nocturne Corian® 64.28 Silky Rose+Deep Nocturne Corian® 45.28 Matt Deluxe Gold+Deep Nocturne Corian®</p>

PHOTO / FOTO	DRAWING / DISEGNO	DESCRIPTION / DESCRIZIONE	Item / Finish Art. / Finitura
  <p data-bbox="159 698 375 716">450x355 166 9 L/min</p>		<p data-bbox="715 376 1094 430">Ceiling-mounted shower head 450x355 mm, 260 mm high.</p> <p data-bbox="715 439 1038 488"><i>Soffione doccia a soffitto 450x355 mm, h. 260 mm.</i></p>	<p data-bbox="1241 383 1353 409">93.7095.6</p> <p data-bbox="1118 465 1455 618"> 10.20 Chrome+Glacier White Corian® 10.28 Chrome+Deep Nocturne Corian® 28.28 Burning Black+Deep Nocturne Corian® 63.28 Royal Black+Deep Nocturne Corian® 64.28 Silky Rose+Deep Nocturne Corian® 45.28 Matt Deluxe Gold+Deep Nocturne Corian® </p>
  <p data-bbox="159 1066 375 1084">450x355 166 9 L/min</p>		<p data-bbox="715 748 1094 801">Ceiling-mounted shower head 450x355 mm, 460 mm high.</p> <p data-bbox="715 810 1038 860"><i>Soffione doccia a soffitto 450x355 mm, h. 460 mm.</i></p>	<p data-bbox="1241 748 1353 775">93.7095.8</p> <p data-bbox="1118 815 1455 967"> 10.20 Chrome+Glacier White Corian® 10.28 Chrome+Deep Nocturne Corian® 28.28 Burning Black+Deep Nocturne Corian® 63.28 Royal Black+Deep Nocturne Corian® 64.28 Silky Rose+Deep Nocturne Corian® 45.28 Matt Deluxe Gold+Deep Nocturne Corian® </p>

Showers



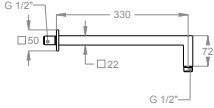


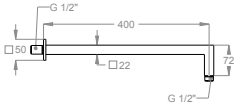


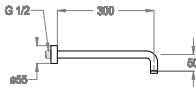




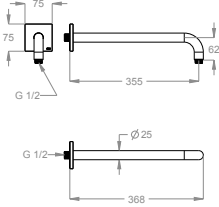

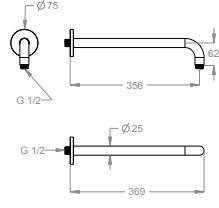

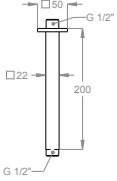

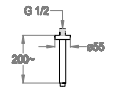
PHOTO / FOTO	DRAWING / DISEGNO	DESCRIPTION / DESCRIZIONE	Item / Finish Art. / Finitura
 		<p>Wall-mounted shower arm, 330 mm long. <i>Braccio doccia a parete, lunghezza 330 mm.</i></p>	<p>05.5422.8</p> <p>10.00 Chrome 33.00 Light Sand 28.00 Burning Black 63.00 Royal Black 64.00 Silky Rose 45.00 Matt Deluxe Gold</p>
 		<p>Wall-mounted shower arm, 400 mm long. <i>Braccio doccia a parete, lunghezza 400 mm.</i></p>	<p>05.5424.8</p> <p>10.00 Chrome 33.00 Light Sand 28.00 Burning Black 63.00 Royal Black 64.00 Silky Rose 45.00 Matt Deluxe Gold</p>
 		<p>Wall-mounted shower arm, 300 mm long. <i>Braccio doccia a parete, lunghezza 300 mm.</i></p>	<p>05.5414.2</p> <p>10.00 Chrome 33.00 Light Sand 28.00 Burning Black 63.00 Royal Black 64.00 Silky Rose 45.00 Matt Deluxe Gold</p>
 		<p>Wall-mounted shower arm, 400 mm long. <i>Braccio doccia a parete, lunghezza 400 mm.</i></p>	<p>05.5414.1</p> <p>10.00 Chrome 33.00 Light Sand 28.00 Burning Black 63.00 Royal Black 64.00 Silky Rose 45.00 Matt Deluxe Gold</p>

PHOTO / FOTO	DRAWING / DISEGNO	DESCRIPTION / DESCRIZIONE	Item / Finish Art./ Finitura
		<p>Wall-mounted shower arm, 355 mm long. <i>Braccio doccia a parete, lunghezza 355 mm.</i></p>	<p>05.5413.2</p> <p>50.00 Stainless Steel</p>
		<p>Wall-mounted shower arm, 355 mm long. <i>Braccio doccia a parete, lunghezza 355 mm.</i></p>	<p>05.5413.1</p> <p>50.00 Stainless Steel</p>
		<p>Ceiling-mounted shower arm, 200 mm high. <i>Braccio doccia a soffitto, h. 200 mm.</i></p>	<p>05.5404.1</p> <p>10.00 Chrome 33.00 Light Sand 28.00 Burning Black 63.00 Royal Black 64.00 Silky Rose 45.00 Matt Deluxe Gold</p>
		<p>Ceiling-mounted shower arm, 200 mm high. <i>Braccio doccia a soffitto, h. 200 mm.</i></p>	<p>05.5403.1</p> <p>10.00 Chrome 33.00 Light Sand 28.00 Burning Black 63.00 Royal Black 64.00 Silky Rose 45.00 Matt Deluxe Gold</p>

Showers



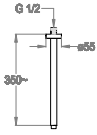


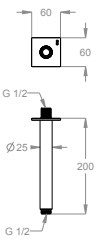


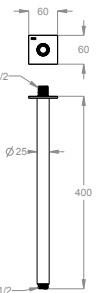


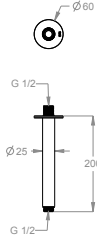


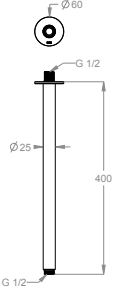






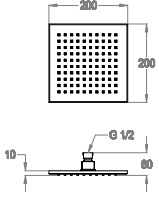






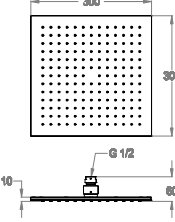






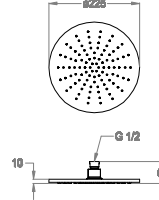
PHOTO / FOTO	DRAWING / DISEGNO	DESCRIPTION / DESCRIZIONE	Item / Finish Art./ Finitura
 		<p>Ceiling-mounted shower arm, 350 mm high. <i>Braccio doccia a soffitto, h. 350 mm.</i></p>	<p>05.5407.1</p> <p>10.00 Chrome 33.00 Light Sand 28.00 Burning Black 63.00 Royal Black 64.00 Silky Rose 45.00 Matt Deluxe Gold</p>
 		<p>Ceiling-mounted shower arm, 200 mm high. <i>Braccio doccia a soffitto, h. 200 mm.</i></p>	<p>05.5402.5</p> <p>50.00 Stainless Steel</p>
 		<p>Ceiling-mounted shower arm, 400 mm high. <i>Braccio doccia a soffitto, h. 400 mm.</i></p>	<p>05.5402.6</p> <p>50.00 Stainless Steel</p>
 		<p>Ceiling-mounted shower arm, 200 mm high. <i>Braccio doccia a soffitto, h. 200 mm.</i></p>	<p>05.5402.2</p> <p>50.00 Stainless Steel</p>

PHOTO / FOTO	DRAWING / DISEGNO	DESCRIPTION / DESCRIZIONE	Item / Finish Art. / Finitura
 		<p>Ceiling-mounted shower arm, 400 mm high. <i>Braccio doccia a soffitto, h. 400 mm.</i></p>	<p>05.5402.4</p> <p>50.00 Stainless Steel</p>
      <p>200x200 100 8 L/min 22 L/min</p>		<p>Shower head 200x200 mm. <i>Soffione doccia 200x200 mm.</i></p>	<p>04.2333.0</p> <p>10.00 Chrome 33.00 Light Sand 28.00 Burning Black 63.00 Royal Black 64.00 Silky Rose 45.00 Matt Deluxe Gold</p>
      <p>300x300 169 8 L/min 24 L/min</p>		<p>Shower head 300x300 mm. <i>Soffione doccia 300x300 mm.</i></p>	<p>04.2337.0</p> <p>10.00 Chrome 33.00 Light Sand 28.00 Burning Black 63.00 Royal Black 64.00 Silky Rose 45.00 Matt Deluxe Gold</p>
      <p>ø 225 102 6 L/min 22 L/min</p>		<p>Shower head Ø 225 mm. <i>Soffione doccia Ø 225 mm.</i></p>	<p>04.2310.0</p> <p>10.00 Chrome 33.00 Light Sand 28.00 Burning Black 63.00 Royal Black 64.00 Silky Rose 45.00 Matt Deluxe Gold</p>

Showers


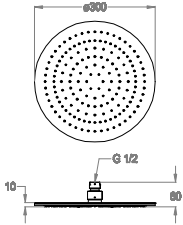


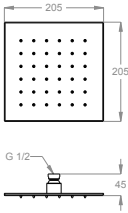


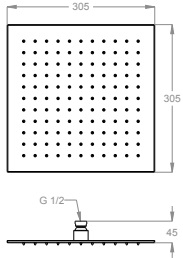


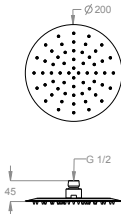


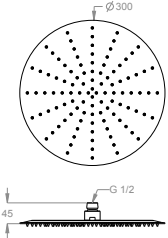


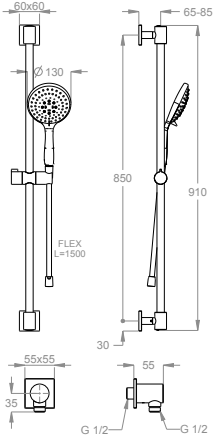


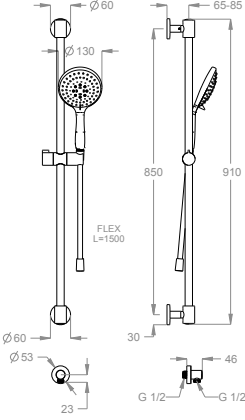

PHOTO / FOTO	DRAWING / DISEGNO	DESCRIPTION / DESCRIZIONE	Item / Finish Art./ Finitura
  	<p>Shower head Ø 300 mm. <i>Soffione doccia Ø 300 mm.</i></p>	<p>04.2312.0</p> <p>10.00 Chrome 33.00 Light Sand 28.00 Burning Black 63.00 Royal Black 64.00 Silky Rose 45.00 Matt Deluxe Gold</p>	
  	<p>Shower head 205x205 mm. <i>Soffione doccia 205x205 mm.</i></p>	<p>04.2334.0</p> <p>50.00 Stainless Steel</p>	
  	<p>Shower head 305x305 mm. <i>Soffione doccia 305x305 mm.</i></p>	<p>04.2338.0</p> <p>50.00 Stainless Steel</p>	
  	<p>Shower head Ø 200 mm. <i>Soffione doccia Ø 200 mm.</i></p>	<p>04.2308.0</p> <p>50.00 Stainless Steel</p>	
  	<p>Shower head Ø 300 mm. <i>Soffione doccia Ø 300 mm.</i></p>	<p>04.2313.0</p> <p>50.00 Stainless Steel</p>	

PHOTO / FOTO	DRAWING / DISEGNO	DESCRIPTION / DESCRIZIONE	Item / Finish Art./ Finitura
  		<p>Vertical bar with multifunctional hand shower, flex and wall water inlet with bayonet connection.</p> <p><i>Asta a parete con doccetta multifunzione, flex e presa d'acqua con fissaggio a baionetta.</i></p>	<p>14.0098.3</p> <p>10.00 Chrome 33.00 Light Sand 28.00 Burning Black 63.00 Royal Black 64.00 Silky Rose 45.00 Matt Deluxe Gold</p>
  		<p>Vertical bar with multifunctional hand shower, flex and wall water inlet with bayonet connection.</p> <p><i>Asta a parete con doccetta multifunzione, flex e presa d'acqua con fissaggio a baionetta.</i></p>	<p>14.0091.6</p> <p>10.00 Chrome 33.00 Light Sand 28.00 Burning Black 63.00 Royal Black 64.00 Silky Rose 45.00 Matt Deluxe Gold</p>

Showers



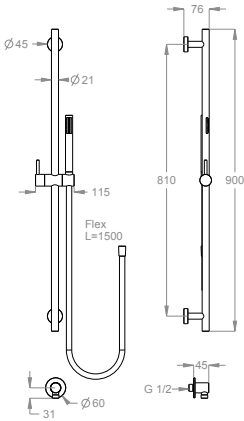


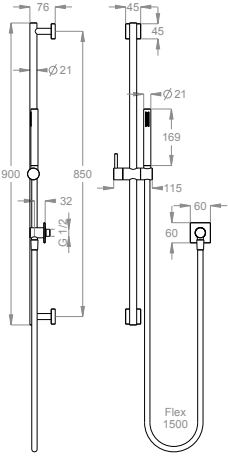
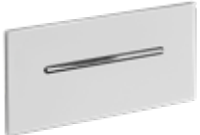

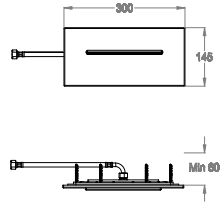


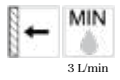
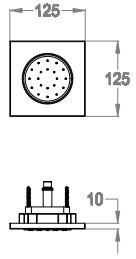


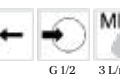
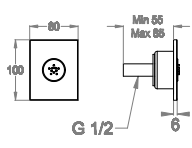

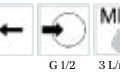
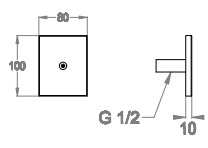

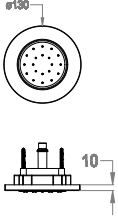

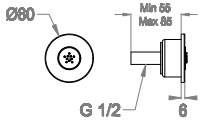

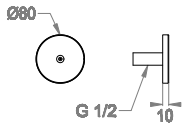
PHOTO / FOTO	DRAWING / DISEGNO	DESCRIPTION / DESCRIZIONE	Item / Finish Art./ Finitura
 		<p>Vertical bar with hand shower, flex and wall water inlet. <i>Asta a parete con doccetta duplex, flex e presa d'acqua.</i></p>	<p>48.0098.1</p> <p>50.00 Stainless Steel</p>
 		<p>Vertical bar with hand shower, flex and wall water inlet. <i>Asta a parete con doccetta duplex, flex e presa d'acqua.</i></p>	<p>58.0098.1</p> <p>50.00 Stainless Steel</p>

PHOTO / FOTO	DRAWING / DISEGNO	DESCRIPTION / DESCRIZIONE	Item / Finish Art./ Finitura
 		<p>External part for built-in wall-mounted cascade water spout 1/2", with cover plate 300x145 mm.</p> <p><i>Parte esterna bocca di erogazione incasso a cascata a parete, ingresso acqua 1/2", con piastra, 300x145 mm.</i></p> <p>Necessary complementary items <i>Articoli complementari necessari</i> 05.2449.0</p> <p> Built-in part for built-in wall-mounted cascade water spout 1/2" 00.00 Natural Color</p> <p><i>Parte incasso bocca di erogazione a cascata a parete, ingresso acqua 1/2".</i></p>	<p>85.4413.8</p> <p>10.00 Chrome 33.00 Light Sand 28.00 Burning Black 63.00 Royal Black 64.00 Silky Rose 45.00 Matt Deluxe Gold 50.00 Stainless Steel</p>
 		<p>External part for built-in wall-mounted square lateral adjustable shower body spray 125x125 mm, with rain jet.</p> <p><i>Parte esterna soffione doccia body jet laterale incasso quadrato orientabile 125x125 mm, con getto pioggia.</i></p> <p>Necessary complementary items <i>Articoli complementari necessari</i> 05.2449.1</p> <p> Built-in part for lateral shower body spray. 00.00 Natural Color</p> <p><i>Parte incasso soffione doccia body jet laterale.</i></p>	<p>14.7032.8</p> <p>10.00 Chrome 33.00 Light Sand 28.00 Burning Black 63.00 Royal Black 64.00 Silky Rose 45.00 Matt Deluxe Gold</p>
 		<p>Built-in wall-mounted square lateral adjustable shower body spray 80x100 mm, with rain jet.</p> <p><i>Soffione doccia body jet laterale incasso quadrato orientabile 80x100 mm, con getto pioggia.</i></p>	<p>14.7031.1</p> <p>10.00 Chrome 33.00 Light Sand 28.00 Burning Black 63.00 Royal Black 64.00 Silky Rose 45.00 Matt Deluxe Gold 50.00 Stainless Steel</p>
 		<p>Built-in wall-mounted square lateral shower body spray 80x100 mm, with nebulizer jet.</p> <p><i>Soffione doccia body jet laterale incasso quadrato 80x100 mm, con getto nebulizzato.</i></p>	<p>14.7031.2</p> <p>10.00 Chrome 33.00 Light Sand 28.00 Burning Black 63.00 Royal Black 64.00 Silky Rose 45.00 Matt Deluxe Gold</p>

Showers

PHOTO / FOTO	DRAWING / DISEGNO	DESCRIPTION / DESCRIZIONE	Item / Finish Art./ Finitura
		<p>External part for built-in wall-mounted round lateral adjustable shower body spray \varnothing 130 mm, with rain jet. <i>Parte esterna soffione doccia body jet laterale incasso rotondo orientabile \varnothing 130 mm, con getto pioggia.</i></p> <p>Necessary complementary items <i>Articoli complementari necessari</i></p> <p>05.2449.1 Built-in part for lateral shower body spray. 00.00 Natural Color <i>Parte incasso soffione doccia body jet laterale.</i></p>	<p>14.7010.8</p> <p>10.00 Chrome 33.00 Light Sand 28.00 Burning Black 63.00 Royal Black 64.00 Silky Rose 45.00 Matt Deluxe Gold</p>
		<p>Built-in wall-mounted round lateral adjustable shower body spray \varnothing 80 mm, with rain jet. <i>Soffione doccia body jet laterale incasso rotondo orientabile \varnothing 80 mm, con getto pioggia.</i></p>	<p>14.7005.1</p> <p>10.00 Chrome 33.00 Light Sand 28.00 Burning Black 63.00 Royal Black 64.00 Silky Rose 45.00 Matt Deluxe Gold 50.00 Stainless Steel</p>
		<p>Built-in wall-mounted round lateral shower body spray \varnothing 80 mm, with nebulizer jet. <i>Soffione doccia body jet laterale incasso rotondo \varnothing 80 mm, con getto nebulizzato.</i></p>	<p>14.7005.2</p> <p>10.00 Chrome 33.00 Light Sand 28.00 Burning Black 63.00 Royal Black 64.00 Silky Rose 45.00 Matt Deluxe Gold</p>

Tap accessories / Accessori rubinetteria



TECHNICAL DATA / DATI TECNICI

65° (max 80° C)

Optimal hot water temperature
Temperatura ottimale acqua calda

3 bar (min 1 - max 5)

Optimal operational pressure
Pressione ottimale di esercizio

0,1 bar (max 1)

Hot/cold water pressure difference
Differenza di pressione acqua calda/fredda

PHOTO / FOTO	DRAWING / DISEGNO	DESCRIPTION / DESCRIZIONE	Item / Finish Art./ Finitura
		<p>Basin trap. <i>Sifone per lavabo.</i></p>	<p>11.5991.5</p> <p>10.00 Chrome 33.00 Light Sand 28.00 Burning Black 63.00 Royal Black 64.00 Silky Rose 45.00 Matt Deluxe Gold</p>
		<p>Basin trap. <i>Sifone per lavabo.</i></p>	<p>11.5992.5</p> <p>10.00 Chrome 33.00 Light Sand 28.00 Burning Black 63.00 Royal Black 64.00 Silky Rose 45.00 Matt Deluxe Gold</p>
		<p>Basin trap. <i>Sifone per lavabo.</i></p>	<p>11.5995.5</p> <p>10.00 Chrome 33.00 Light Sand 28.00 Burning Black 63.00 Royal Black 64.00 Silky Rose 45.00 Matt Deluxe Gold</p>
		<p>Bidet trap. <i>Sifone per bidet.</i></p>	<p>11.5981.5</p> <p>10.00 Chrome 33.00 Light Sand 28.00 Burning Black 63.00 Royal Black 64.00 Silky Rose 45.00 Matt Deluxe Gold</p>

Tap accessories / Accessori rubinetteria


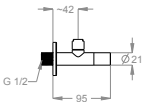

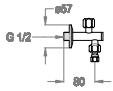

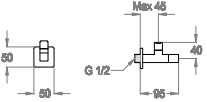

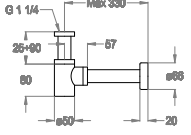

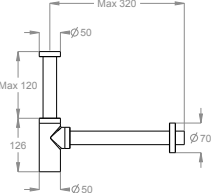

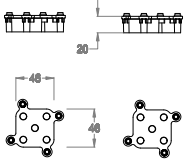


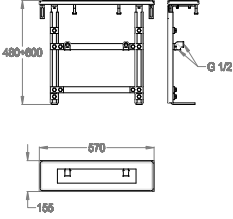


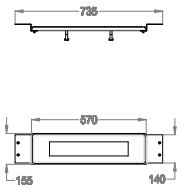


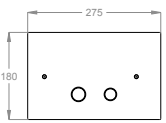

PHOTO / FOTO	DRAWING / DISEGNO	DESCRIPTION / DESCRIZIONE	Item / Finish Art./ Finitura
 		<p>Shut-off valve and filter elbow connection with removable filter for single hole mixers. <i>Rubinetto con filtro estraibile per miscelatore monoforo.</i></p>	<p>11.0506.2</p> <p>50.00 Stainless Steel</p>
 		<p>Shut-off valve and filter elbow connection with removable filter for single hole mixers. <i>Rubinetto con filtro estraibile per miscelatore monoforo.</i></p>	<p>11.0503.2</p> <p>10.00 Chrome 33.00 Light Sand 28.00 Burning Black 63.00 Royal Black 64.00 Silky Rose 45.00 Matt Deluxe Gold</p>
 		<p>Shut-off valve and filter elbow connection with removable filter for single hole mixers. <i>Rubinetto con filtro estraibile per miscelatore monoforo.</i></p>	<p>11.0505.2</p> <p>10.00 Chrome 33.00 Light Sand 28.00 Burning Black 63.00 Royal Black 64.00 Silky Rose 45.00 Matt Deluxe Gold</p>
 		<p>Bidet trap. <i>Sifone per bidet.</i></p>	<p>11.5982.5</p> <p>10.00 Chrome 33.00 Light Sand 28.00 Burning Black 63.00 Royal Black 64.00 Silky Rose 45.00 Matt Deluxe Gold</p>
 		<p>Basin trap. <i>Sifone per lavabo.</i></p>	<p>11.5997.5</p> <p>50.00 Stainless Steel</p>

PHOTO / FOTO	DRAWING / DISEGNO	DESCRIPTION / DESCRIZIONE	Item / Finish Art./ Finitura
		<p>Extension kit for FirUnico®, 20 mm long. <i>Kit prolunga 20 mm per FirUnico®.</i></p>	<p>05.0038.0</p> <p>00.00 Natural Color</p>
 		<p>Assembly system for deck-mounted bath mixer with floor fixing. <i>Sistema di montaggio per bordo vasca con fissaggio a pavimento.</i></p>	<p>05.0080.0</p> <p>05.00 Raw Brass</p>
 		<p>Assembly system for deck-mounted bath mixer with deck fixing. <i>Sistema di montaggio per bordo vasca con fissaggio al piano.</i></p>	<p>05.0081.0</p> <p>05.00 Raw Brass</p>
 		<p>WC flush plate (compatible with Geberit UP320 and UP720 models). <i>Placca per cassetta WC (compatibile con modelli Geberit UP320 e UP720).</i></p>	<p>11.6000.0</p> <p>50.00 Stainless Steel</p>

Tap accessories / Accessori rubinetteria

PHOTO / FOTO	DRAWING / DISEGNO	DESCRIPTION / DESCRIZIONE	Item / Finish Art./ Finitura
		Pop-up drain 1 1/4", Clic/Clac round plug type and overflow. <i>Scarico Clic/Clac da 1 1/4" con tappo rotondo a pressione, e con troppopieno.</i>	04.1005.0 10.00 Chrome 33.00 Light Sand 28.00 Burning Black 63.00 Royal Black 64.00 Silky Rose 45.00 Matt Deluxe Gold
		Pop-up drain 1 1/4", Clic/Clac round plug type and overflow. <i>Scarico Clic/Clac da 1 1/4" con tappo rotondo a pressione, e con troppopieno.</i>	04.1004.6 10.00 Chrome 33.00 Light Sand 28.00 Burning Black 63.00 Royal Black 64.00 Silky Rose 45.00 Matt Deluxe Gold
		Pop-up drain 1 1/4", Clic/Clac square plug type and overflow. <i>Scarico Clic/Clac da 1 1/4" con tappo quadrato a pressione, e con troppopieno.</i>	04.1004.8 10.00 Chrome 33.00 Light Sand 28.00 Burning Black 63.00 Royal Black 64.00 Silky Rose 45.00 Matt Deluxe Gold
		Pop-up drain 1 1/4", Clic/Clac round plug type in stainless steel, with overflow. <i>Scarico Clic/Clac da 1 1/4" con tappo in acciaio inossidabile, rotondo a pressione, e con troppopieno.</i>	04.1005.2 50.00 Stainless Steel
		Pop-up drain 1 1/4" in stainless steel, Clic/Clac round plug type. <i>Scarico Clic/Clac in acciaio inossidabile da 1 1/4" con tappo rotondo a pressione.</i>	04.1001.0 50.00 Stainless Steel
		Pop-up drain 1 1/4" in stainless steel, Clic/Clac round plug type and overflow. <i>Scarico Clic/Clac in acciaio inossidabile da 1 1/4" con tappo rotondo a pressione, e con troppopieno.</i>	04.1001.1 50.00 Stainless Steel

Built-in parts / Parti incasso



TECHNICAL DATA / DATI TECNICI

65° (max 80° C)


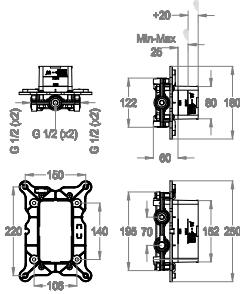
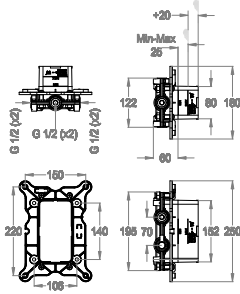

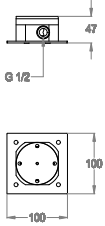
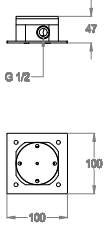

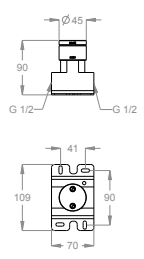
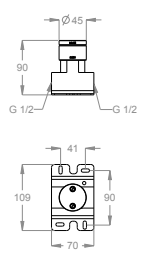

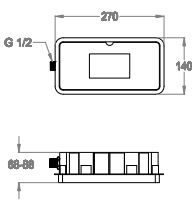
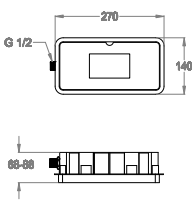
Optimal hot water temperature
Temperatura ottimale acqua calda

3 bar (min 1 - max 5)


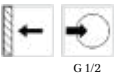
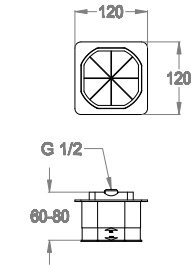


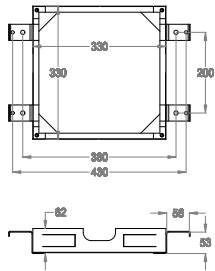


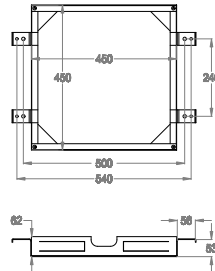


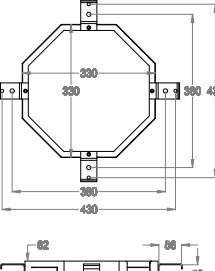


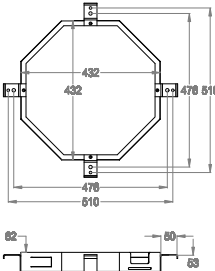
Optimal operational pressure
Pressione ottimale di esercizio

0,1 bar (max 1)































Hot/cold water pressure difference
Differenza di pressione acqua calda/fredda

PHOTO / FOTO	DRAWING / DISEGNO	DESCRIPTION / DESCRIZIONE	Item / Finish Art./ Finitura
  <p>4+1 OUTLETS DVGW DVGW CBIT CBIT EN 817 EN 1111</p>		<p>FirUnico® universal built-in system. <i>Sistema incasso universale FirUnico®.</i></p>	<p>05.1000.0</p> <p>05.00 Raw Brass</p>
  <p>G 1/2</p>		<p>Built-in part for mixer. <i>Parte incasso miscelatore.</i></p>	<p>05.2146.4</p> <p>05.00 Raw Brass</p>
  <p>G 1/2</p>		<p>Built-in part for mixer. <i>Parte incasso miscelatore.</i></p>	<p>05.2147.4</p> <p>05.00 Raw Brass</p>
  <p>G 1/2</p>		<p>Built-in part for built-in wall-mounted cascade water spout 1/2". <i>Parte incasso bocca di erogazione a cascata a parete, ingresso acqua 1/2".</i></p>	<p>05.2449.0</p> <p>00.00 Natural Color</p>

Built-in parts / Parti incasso

PHOTO / FOTO	DRAWING / DISEGNO	DESCRIPTION / DESCRIZIONE	Item / Finish Art./ Finitura
 		<p>Built-in part for lateral shower body spray. <i>Parte incasso soffione doccia body jet laterale.</i></p>	<p>05.2449.1</p> <p>00.00 Natural Color</p>
 		<p>Built-in part for ceiling-mounted shower head. <i>Parte incasso soffione doccia incasso a soffitto.</i></p>	<p>05.2449.2</p> <p>00.00 Natural Color</p>
 		<p>Built-in part for ceiling-mounted shower head. <i>Parte incasso soffione doccia incasso a soffitto.</i></p>	<p>05.2449.3</p> <p>00.00 Natural Color</p>
 		<p>Built-in part for ceiling-mounted shower head. <i>Parte incasso soffione doccia incasso a soffitto.</i></p>	<p>05.2449.4</p> <p>00.00 Natural Color</p>
 		<p>Built-in part for ceiling-mounted shower head. <i>Parte incasso soffione doccia incasso a soffitto.</i></p>	<p>05.2449.5</p> <p>00.00 Natural Color</p>

Symbols key / Legenda icone

	Item requiring a deck installation. <i>Articolo che prevede un'installazione al piano.</i>		Item equipped with Fast&Easy Clean anti-limescale nozzle system for removing limescale with a simple hand gesture. <i>Articolo dotato di sistema con ugelli anticalcare Fast&Easy Clean, per la rimozione del calcare con un semplice gesto della mano.</i>		Multifunctional hand shower code nr. <i>Codice articolo della doccetta multifunzione.</i>
	Item requiring a wall installation. <i>Articolo che prevede un'installazione a parete.</i>		Thermostatic item. <i>Articolo termostatico.</i>		Universal built-in system equipped with 4 side outlets for shower mixer + 1 frontal outlet for wash basin mixer. <i>Sistema incasso universale dotato di 4 uscite laterali per miscelatore doccia + 1 frontale per miscelatore lavabo.</i>
	Item requiring a ceiling installation. <i>Articolo che prevede un'installazione a soffitto.</i>		Item equipped with ceramic disc cartridge. <i>Articolo con cartuccia a dischi ceramici.</i>		DVGW certified item. <i>Articolo certificato DVGW.</i>
	Item that requires false ceiling. <i>Articolo che richiede controsoffittatura.</i>		Item with thermostatic cartridge. <i>Articolo con cartuccia termostatica.</i>		DVGW certified item. <i>Articolo certificato DVGW.</i>
	Item requiring a floor installation. <i>Articolo che prevede un'installazione a pavimento.</i>		Item equipped with diverter cartridge. <i>Articolo con cartuccia deviatrice.</i>		Hand shower wall support with anti-scratch inner protection. <i>Supporto doccia con copertura interna antigraffio.</i>
	Item with "tonic" jet. The jet-breaker provides a mixture of water and revitalising and invigorating air. <i>Articolo con getto "tonic". Dal rompigetto sgorga una miscela di acqua e aria tonificante e rigenerante.</i>		Item with two inlets and one outlet. <i>Articolo con due entrate e una uscita.</i>		Article equipped with a system that allows a precise and easy installation. <i>Articolo dotato di sistema di regolazione precisa e facilitata.</i>
	Item equipped with cache aerator. <i>Articolo dotato di aeratore cachè.</i>		Item with two inlets and two outlets. <i>Articolo con due entrate e due uscite.</i>		
	Item equipped with positionable aerator. <i>Articolo dotato di aeratore orientabile.</i>		Item with two inlets and three outlets. <i>Articolo con due entrate e tre uscite.</i>		
	Item equipped with flex hoses. <i>Articolo con attacchi flessibili.</i>		Item with two inlets and four outlets. <i>Articolo con due entrate e quattro uscite.</i>		
	Water inlet. <i>Ingresso acqua.</i>		Item equipped with pop-up drain and pull-rod. <i>Articolo dotato di scarico e asta con salterello.</i>		
	Water outlet. <i>Uscita acqua.</i>		Length of the anti-torsion PVC hose. <i>Lunghezza del flessibile antitorsione in PVC.</i>		
	Size of the square shower head. <i>Misura del soffione doccia quadrato.</i>		Minimum water flow rate recommended for the correct functioning of the item. <i>Portata minima di acqua consigliata per il corretto funzionamento dell'articolo.</i>		
	Size of the round/oval shower head. <i>Misura del soffione doccia tondo/ovale.</i>		Maximum flow rate the item can deliver. <i>Portata massima di acqua che può erogare l'articolo.</i>		
	Number of nozzles of the shower head. <i>Numero ugelli del soffione doccia.</i>		Water saving item. <i>Articolo a risparmio idrico.</i>		
	Hand shower code nr. <i>Codice articolo della doccetta.</i>		Item on which you can mount a flow reducer (see tap accessory section). <i>Articolo su cui è possibile montare un riduttore di portata (vedere sezione accessori rubinetterie).</i>		

"Stay hungry, stay foolish."

S. Jobs 1955-2011

in collaborazione con:

ARBI
BATHROOM



PROJECT BY TERRATINTA MKTG LAB
PRINTED IN ITALY, **September 2020**
TERRATINTA CERAMICHE ALL RIGHTS RESERVED

C
H
A
N
G
E

WE CAN
CHANGE
HABITS
**NOT OUR
PLANET**

BY
TERRATINTA
group



atmosfere 
The unexpected feel

A BRAND of TERRATINTAGROUP
Via Monte Bianco 55 - 41042 Fiorano Modenese
(MO) Italy | Tel. +39 0536911408
www.atmosfere.design